

Billing Boats®

MERCANTIC 424 * *

PHOTO MANUAL



DK MERCANTIC

M/S Mercantic (byggenr. 84) blev bygget i 1964 af H. C. Christensens Staalskibsværft, Marstal, Danmark, bestilt af Per Henriksen og var Mercandia rederiets første skib. Længde: 48,01 m. Bredde: 9,10 m. Dybgang: 3,33 m. Brt. 299 Nrt. 200 Tdw 625. Kaldesignal OZHA Hovedmaskine: 1 stk. B&W/Alpha 405-24VO. HK: 425 bhk. KW: 313. Fart i knob: 10,0. M/S Mercantic var et traditionelt fragtskib hvis type var udbredt i 1960'erne og frem til starten af halvfemserne. M/S Mercantic blev solgt og omdøbt flere gange. I 2004 Blev hun solgt til Wade Group, Portsmouth, Dominikanske Republik og omdøbt til "Love Divine". Grundstødt 22/8 2012 på Bequia Island, Vest Indien. Erklæret CTL.

GB MERCANTIC

M/S Mercantic (build no. 84) was built in 1964 by H. C. Christensens Staalskibsværft, Marstal, Denmark, ordered by Per Henriksen and was the Mercandia shipping lines first ship. LOA 48,01m, Beam 9,10 Draft 3,33 m. Brt. 299 Nrt. 200 Tdw 625. Call signal OZHA. Main engine B&W/Alpha 405-24VO. HK: 425 bhk. KW: 313. Speed 10 knots. M/S Mercantic was a traditional freighter and her kind was very common in the 1960's up to the 1990's. M/S Mercantic was sold and renamed several times. In 2004 she was sold to Wade Group, Portsmouth, Dominican republic and renamed to "Love Divine". Run aground on August 22th 2012, west indies and declared CTL.

D MERCANTIC

Die M/S Mercantic (Bau-Nr. 84) wurde 1964 von H. C. Christensens Staalskibsværft, Marstal, Dänemark im Auftrag von Per Henriksen gebaut und war das erste Schiff der Mercandia-Reederei. Länge 48,01m, Breite 9,10 Tiefgang 3,33 m. Brt. 299 Nrt. 200 Tdw 625. Rufsignal OZHA. Hauptmotor B&W/Alpha 405-24VO. HK: 425 bhk. KW: 313. Geschwindigkeit 10 Knoten. Die M/S Mercantic war ein traditioneller Frachter und ihre Art war in den 1960er bis 1990er Jahren sehr verbreitet. Die M/S Mercantic wurde mehrmals verkauft und umbenannt. Im Jahr 2004 wurde sie an die Wade Group, Portsmouth, Dominikanische Republik verkauft und in "Love Divine" umbenannt. Am 22. August 2012 auf Grund gelaufen, Westindien und CTL deklariert.

F MERCANTIC

Le M/S Mercantic (construction n° 84) a été construit en 1964 par H. C. Christensens Staalskibsværft, Marstal, Danemark, commandé par Per Henriksen et a été le premier navire de la Mercandia shipping lines. LOA 48,01m, Largeur 9,10 Tirant d'eau 3,33 m. Brt. 299 Nrt. 200 Tdw 625. Signal d'appel OZHA. Moteur principal B&W/Alpha 405-24VO. HK: 425 bhk. KW: 313. Vitesse 10 nœuds. Le M/S Mercantic était un cargo traditionnel et son type était très courant dans les années 1960 jusqu'aux années 1990. M/S Mercantic a été vendu et renommé plusieurs fois. En 2004, il a été vendu à Wade Group, Portsmouth, République dominicaine et renommé « Love Divine ». Échoué le 22 août 2012, Antilles et déclaré CTL.

NL MERCANTIC

M/S Mercantic (build nr. 84) werd in 1964 gebouwd door H. C. Christensens Staalskibsværft, Marstal, Denemarken, in opdracht van Per Henriksen en was het eerste schip van de Mercandia-rederij. LOA 48,01m, Breedte 9,10 Diepgang 3,33 m. Brt. 299 Nrt. 200 Tdw 625. Oproepsignaal OZHA. Hoofdmotor B&W/Alpha 405-24VO. HK: 425 pk. KW: 313. Snelheid 10 knopen. M/S Mercantic was een traditioneel vrachtschip en dit type schip was een veel voorkomend schip in de jaren 60 tot 90. M/S Mercantic werd een aantal keren verkocht en hernoemd. In 2004 werd ze verkocht aan Wade Group, Portsmouth, Dominicaanse Republiek en omgedoopt tot "Love Divine". Aan de grond gelopen op 22 augustus 2012, West-Indië en total loss verklaard.

E MERCANTIC

El M/S Mercantic (n.º de construcción 84) fue construido en 1964 por H. C. Christensens Staalskibsværft, Marstal, Dinamarca, ordenado por Per Henriksen y fue el primer barco de Mercandia shipping lines. LOA 48,01m, Manga 9,10 Calado 3,33 m. Brt. 299 Nrt. 200 Tdw 625. Señal de llamada OZHA. Motor principal B&W/Alpha 405-24VO. HK: 425 bhk. KW: 313. Velocidad 10 nudos. M/S Mercantic era un carguero tradicional y su tipo era muy común en la década de 1960 hasta la década de 1990. M/S Mercantic fue vendido y renombrado varias veces. En 2004 fue vendido a Wade Group, Portsmouth, República Dominicana y renombrado a "Love Divine". Encallado el 22 de agosto de 2012, Antillas y declarado CTL.

I MERCANTIC















La M/S Mercantic (build no. 84) fu costruita nel 1964 da H. C. Christensens Staalskibsværft, Marstal, Danimarca, ordinata da Per Henriksen e fu la prima nave della Mercandia shipping lines. LOA 48,01m, Larghezza 9,10 Pescaggio 3,33 m. Brt. 299 Nrt. 200 Tdw 625. Segnale di chiamata OZHA. Motore principale B&W/Alpha 405-24VO. HK: 425 bhk. KW: 313. Velocità 10 nodi. M/S Mercantic era un cargo tradizionale e il suo genere era molto comune nel 1960 fino al 1990. M/S Mercantic è stata venduta e rinominata più volte. Nel 2004 è stata venduta al Wade Group, Portsmouth, Repubblica Dominicana e rinominata "Love Divine". Si arena il 22 agosto 2012, le Indie Occidentali e dichiarano CTL.

P MERCANTIC

M/S Mercantic (construção no. 84) foi construído em 1964 por H. C. Christensens Staalskibsværft, Marstal, Dinamarca, encomendado por Per Henriksen e foi o primeiro navio da Mercandia. LOA 48,01m, Feixe 9,10 Calado 3,33m. Brt. 299 Nrt. 200 Tdw 625. Sinal de chamada OZHA. Motor principal B&W/Alpha 405-24VO. Hong Kong: 425 coroaas suecas. QUILOWATT: 313. Velocidade 10 nós. M/S Mercantic era um cargueiro tradicional e seu tipo era muito comum na década de 1960 até a década de 1990. M/S Mercantic foi vendido e renomeado várias vezes. Em 2004 ela foi vendida para Wade Group, Portsmouth, República Dominicana e renomeada para "Love Divine". Encalhar em 22 de agosto de 2012, Índias Ocidentais e CTL declarado.

PL MERCANTIC

M/S Mercantic (nr budowy 84) został zbudowany w 1964 roku przez HC Christensens Staalskibsværft, Marstal, Dania, na zamówienie Pera Henriksena i był pierwszym statkiem linii żeglugowych Mercandia. LOA 48,01 m, szerokość 9,10 zanurzenie 3,33 m. br. 299 nr. 200 Tdw 625. Sygnał wywoławczy OZHA. Silnik główny B&W/Alpha 405-24VO. HK: 425 bhk. KW: 313. Prędkość 10 węzłów. M/S Mercantic był tradycyjnym frachtowcem, a jego rodzaj był bardzo powszechny w latach 60-tych i 90-tych. M/S Mercantic był kilkakrotnie sprzedawany i zmieniał nazwę. W 2004 roku została sprzedana firmie Wade Group z Portsmouth na Dominikanie i przemianowana na „Love Divine”. Osiadł na mieliźnie 22 sierpnia 2012 r. w Indiach zachodnich i ogłosił CTL.

	Part number		Cut out		Paint with primer paint
	Paint number (* alternative colour)		Use putty (fill and sand)		Use cyanoacrylate glue
	Wood stain		Fit to other parts		Give shape (before sticking)
	Rope number		Part made with layers		Give shape (before sticking, if necessary use water)
	Give shape (for example use sand paper)		Drill a hole		

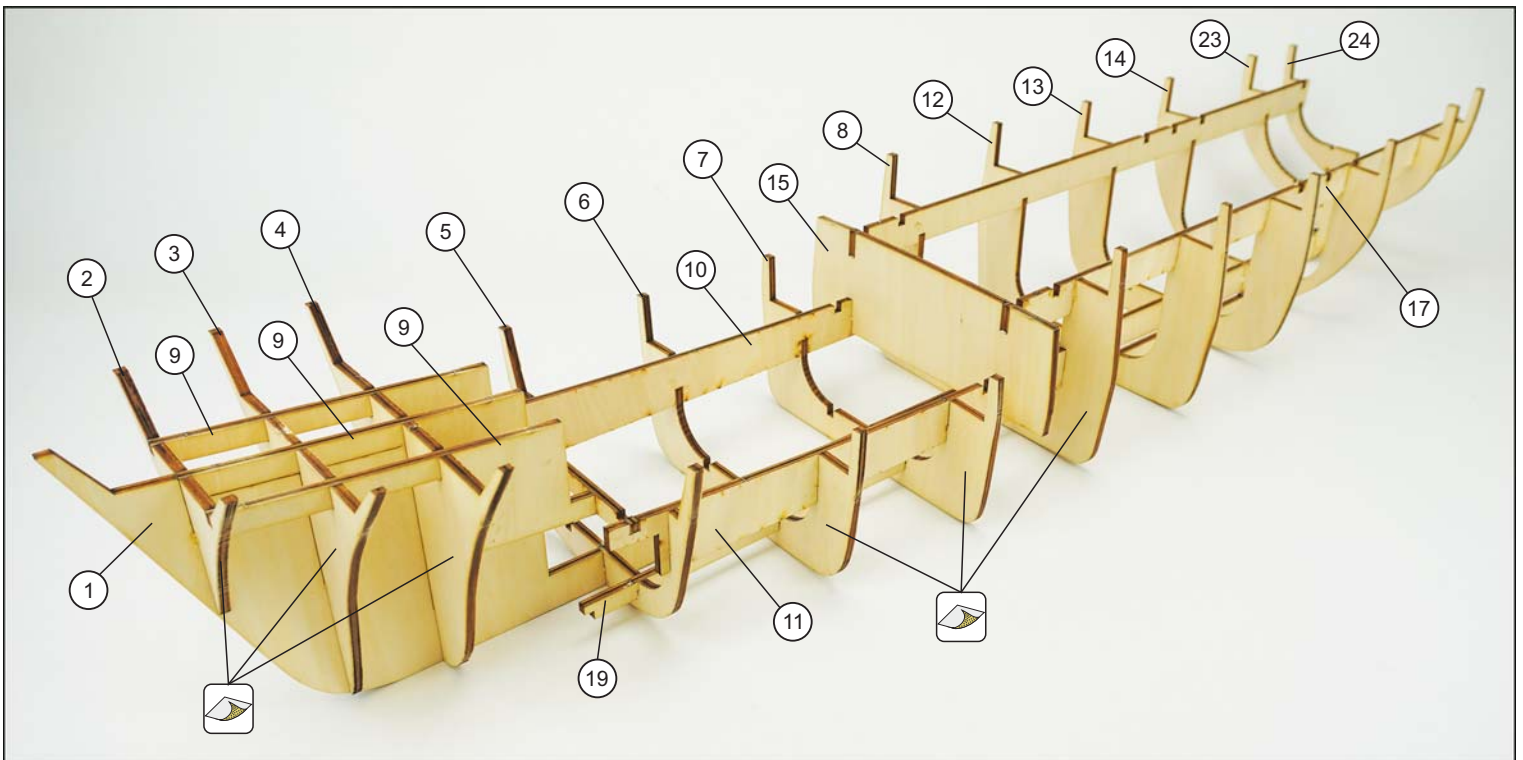
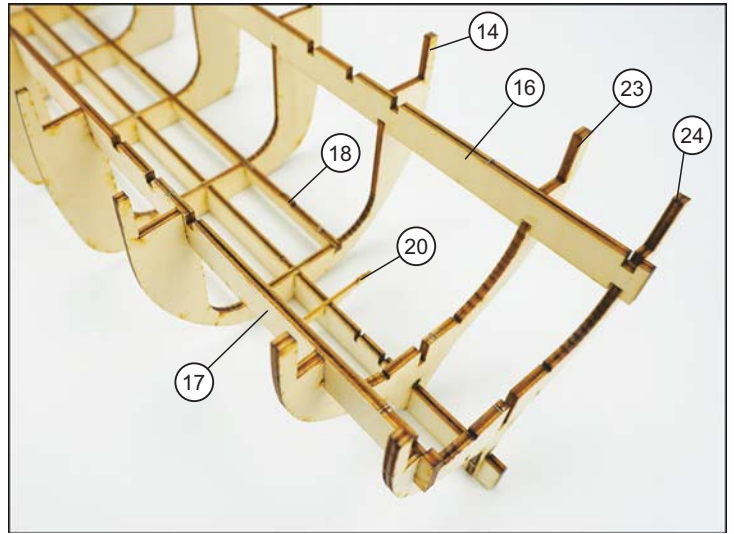
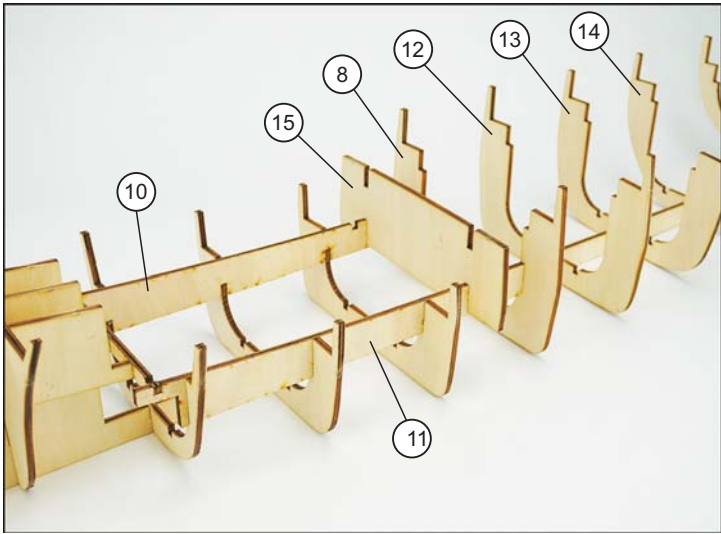
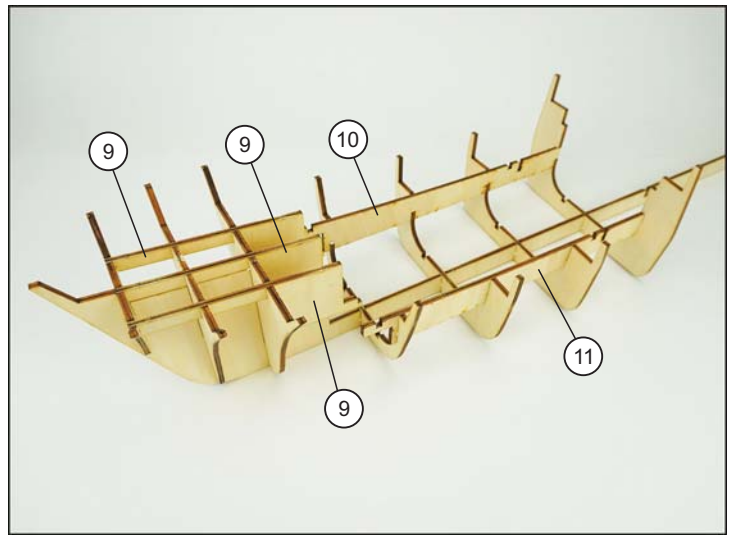
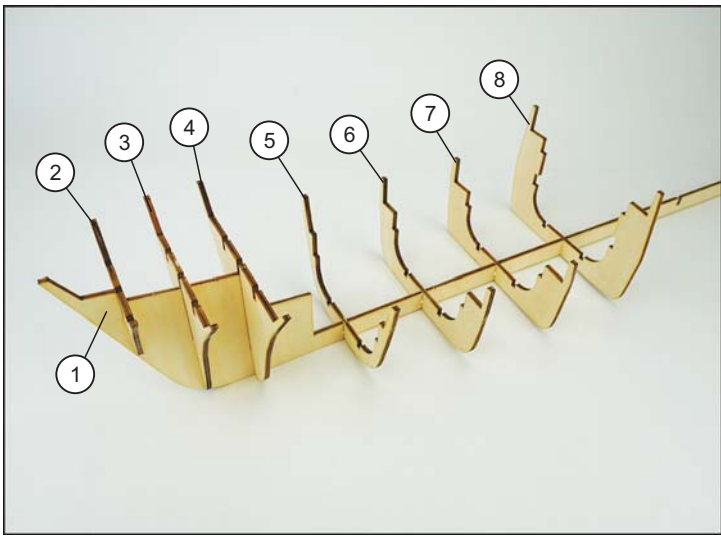

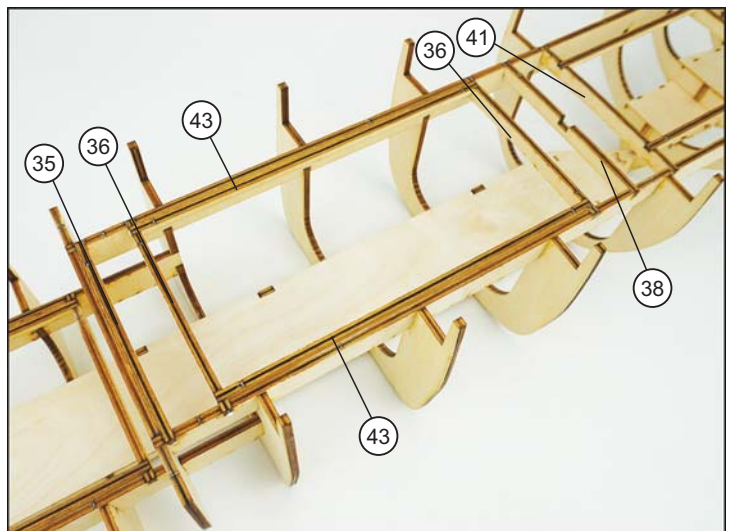
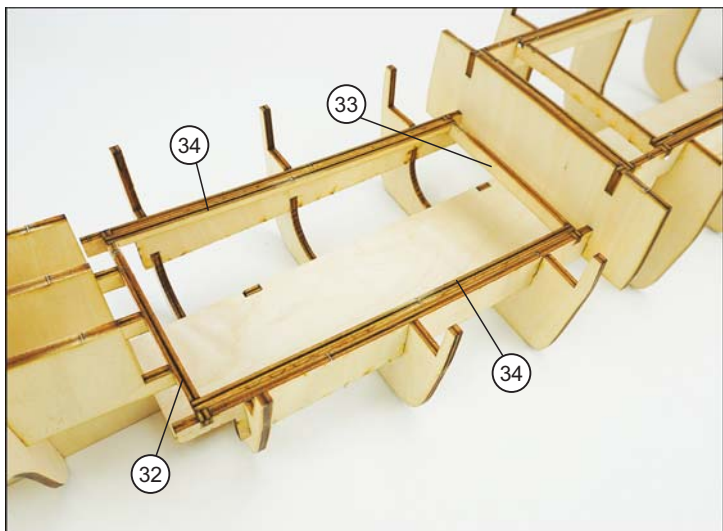
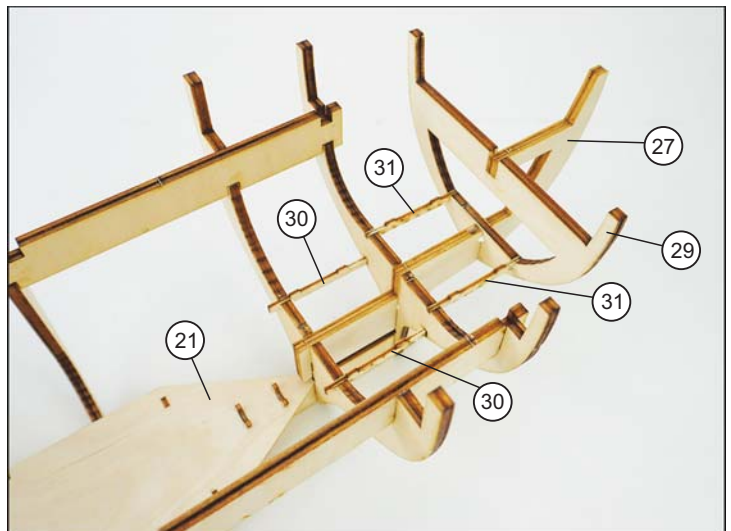
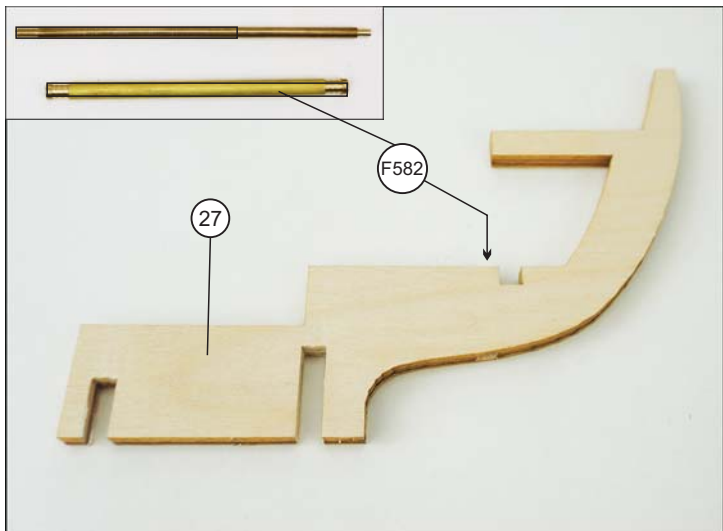
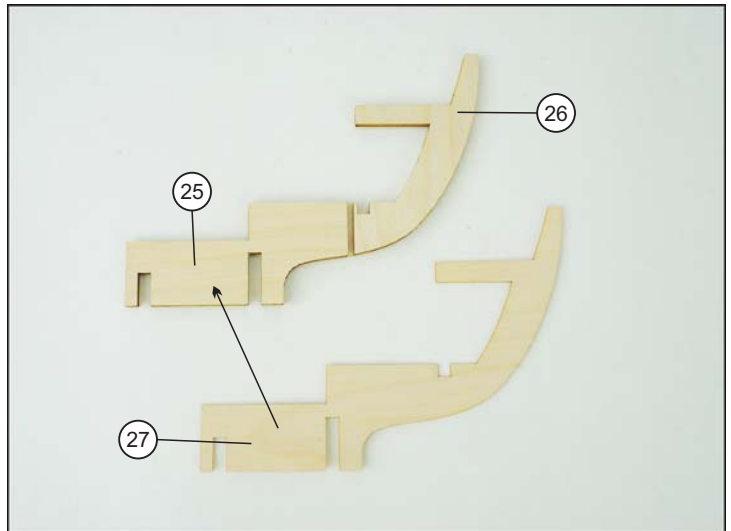
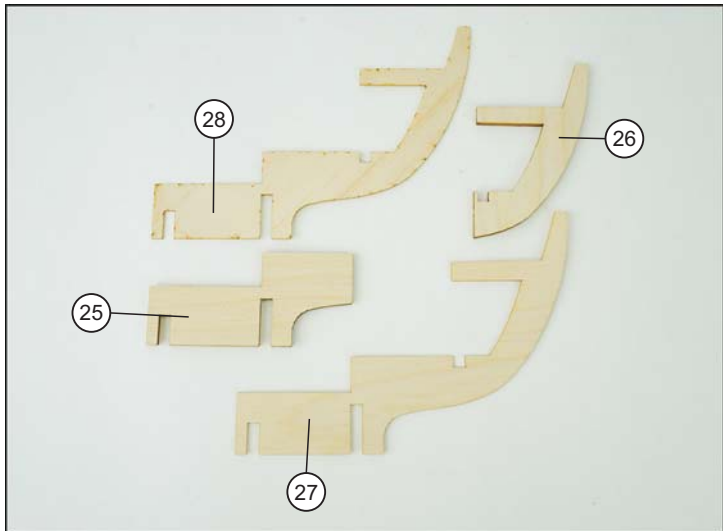
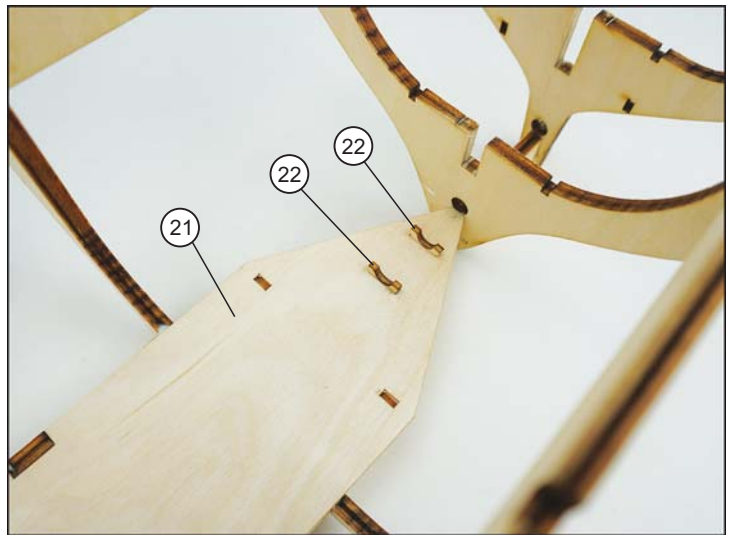
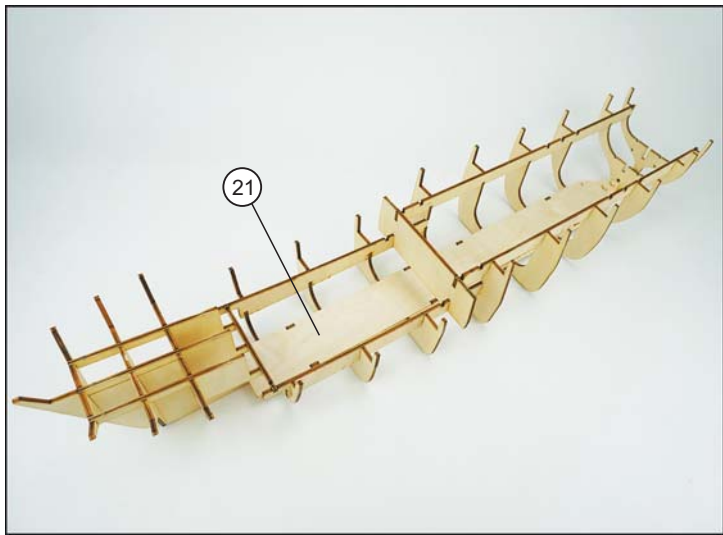

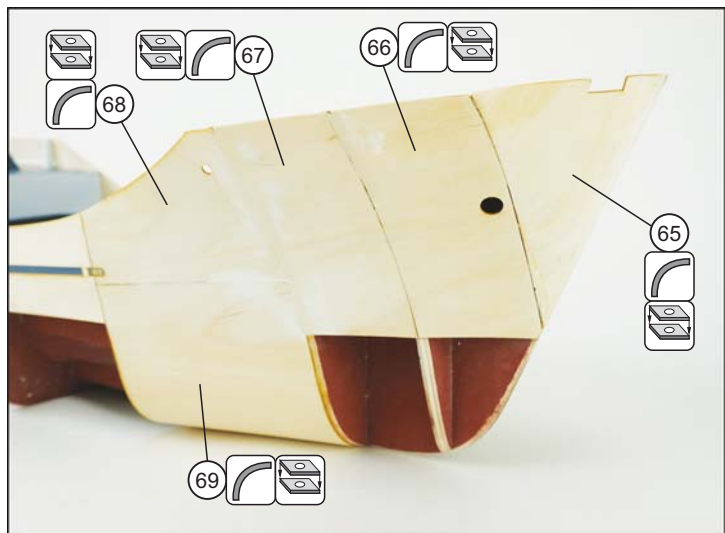
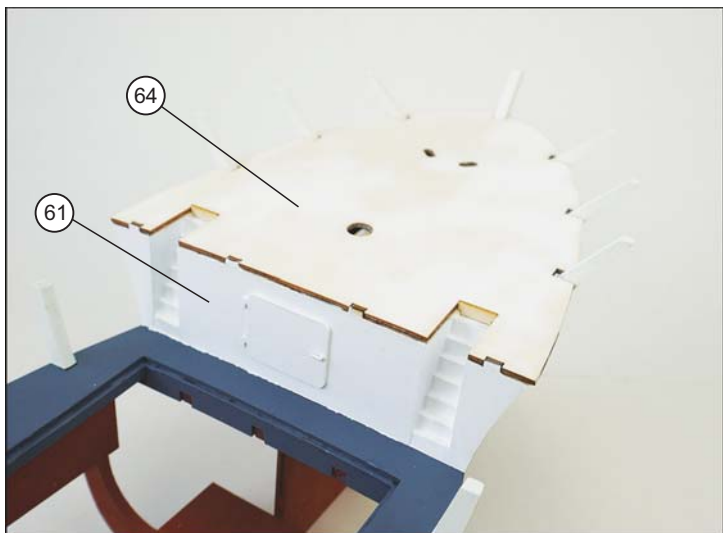
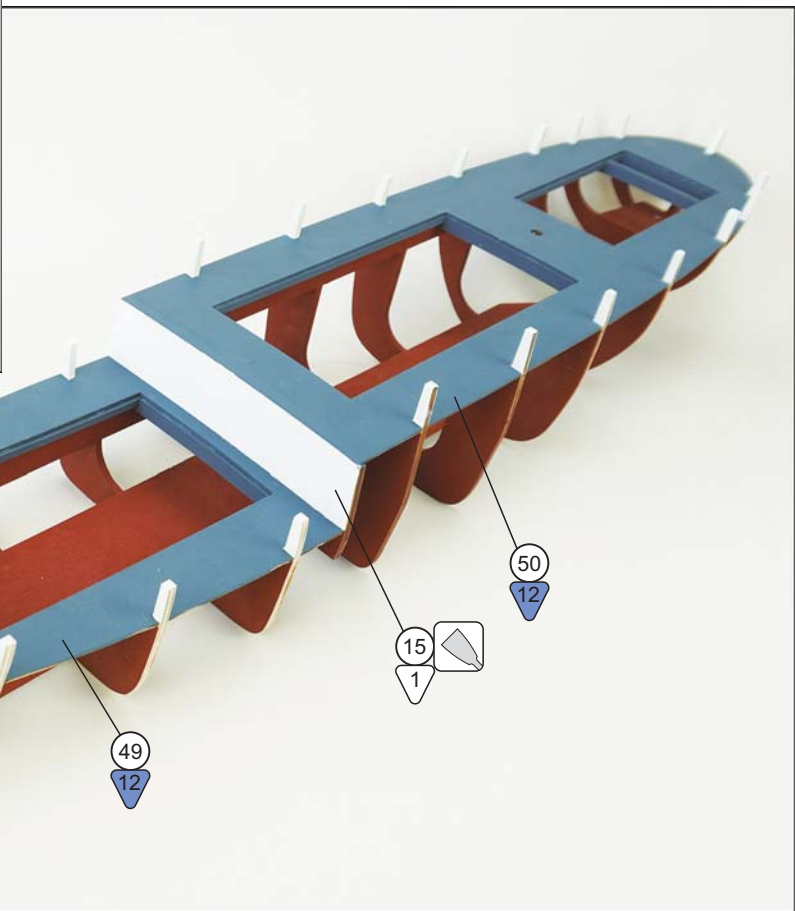
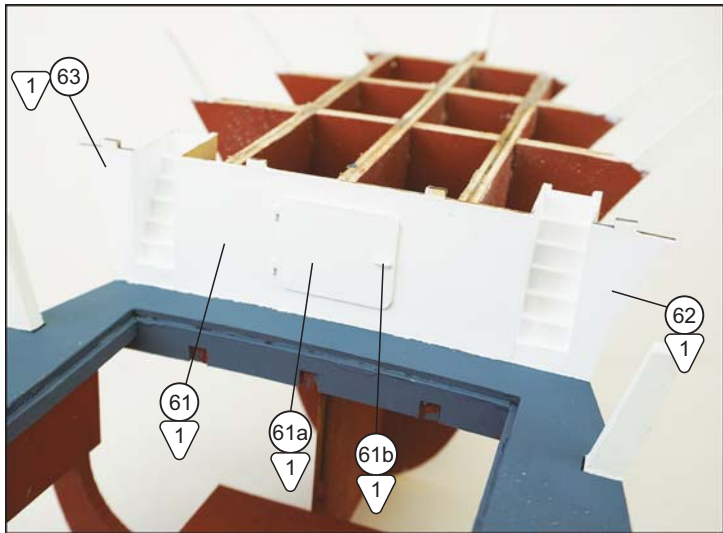
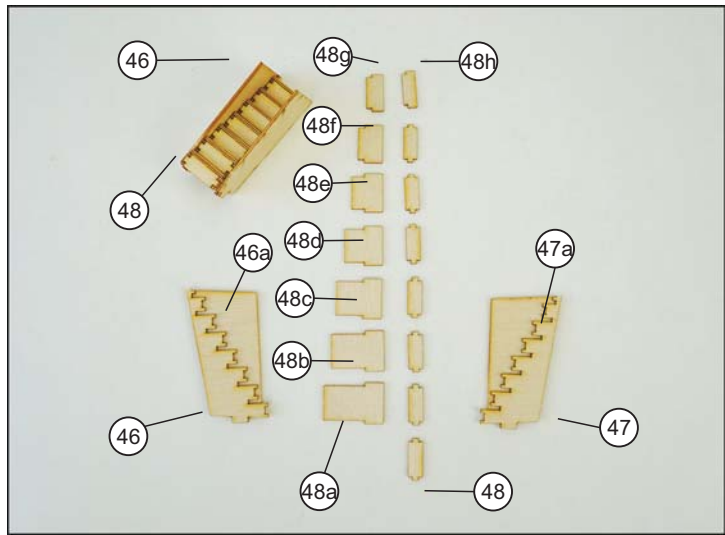
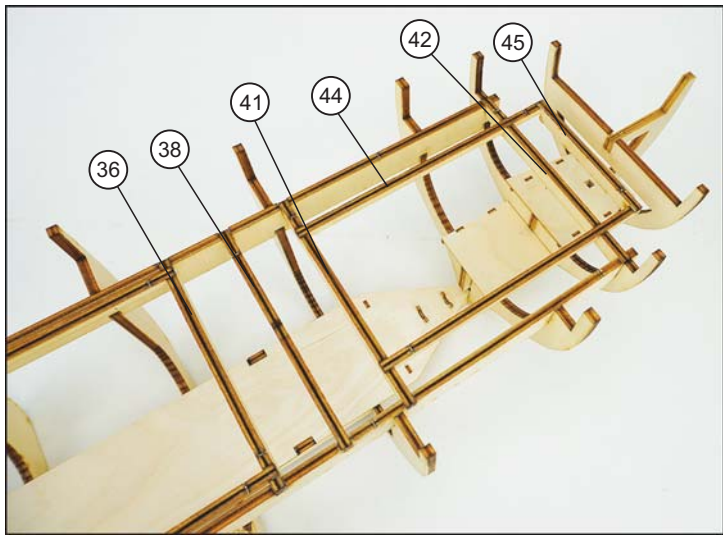

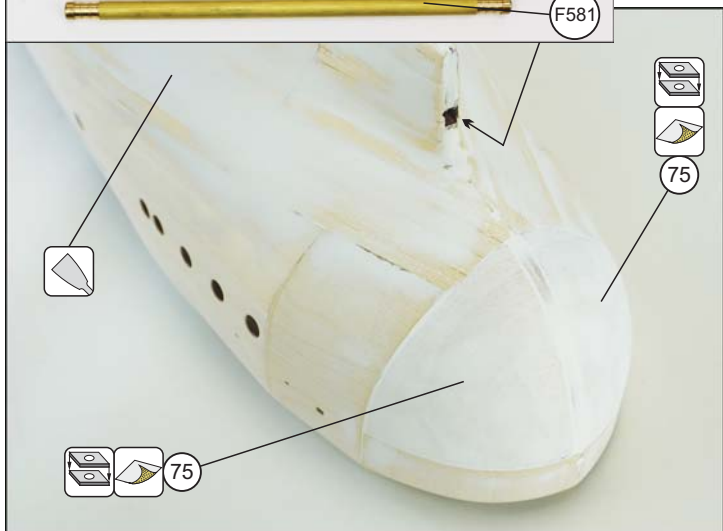
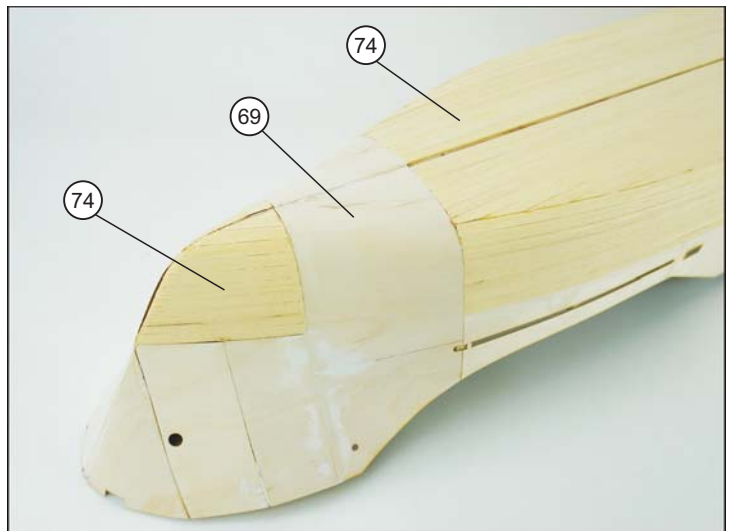
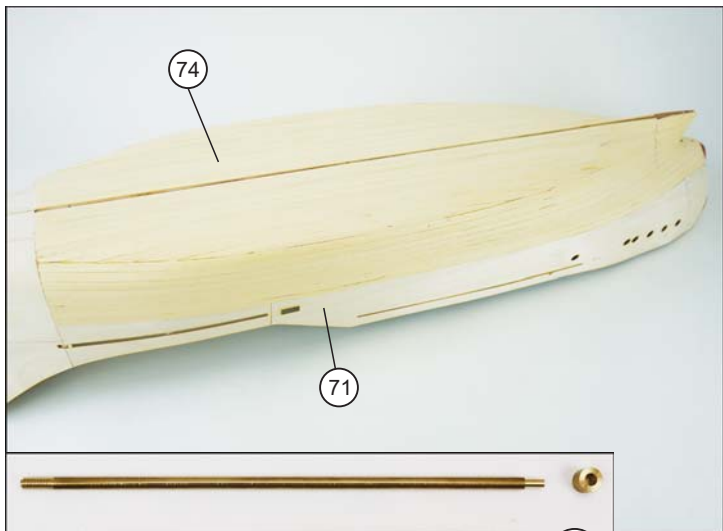
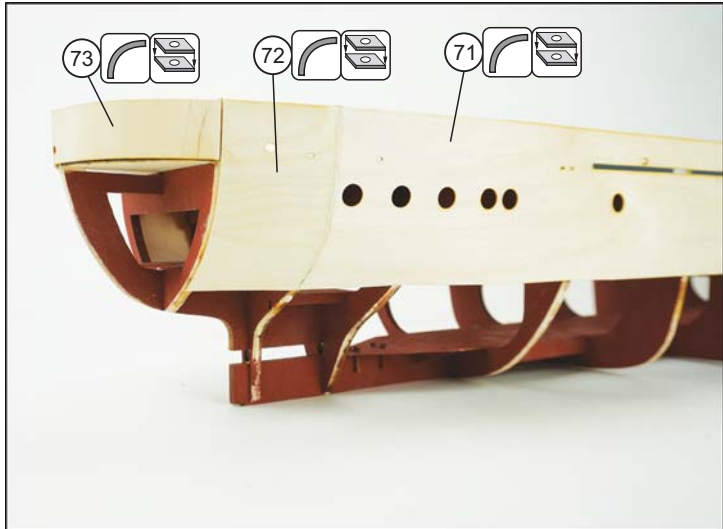
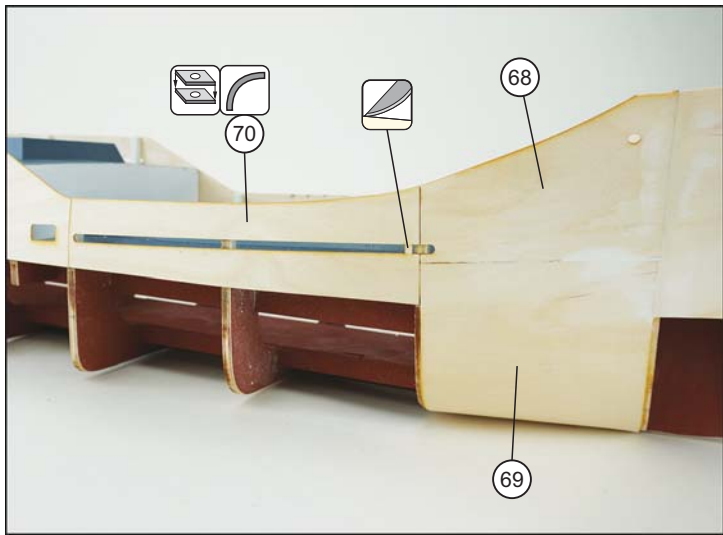

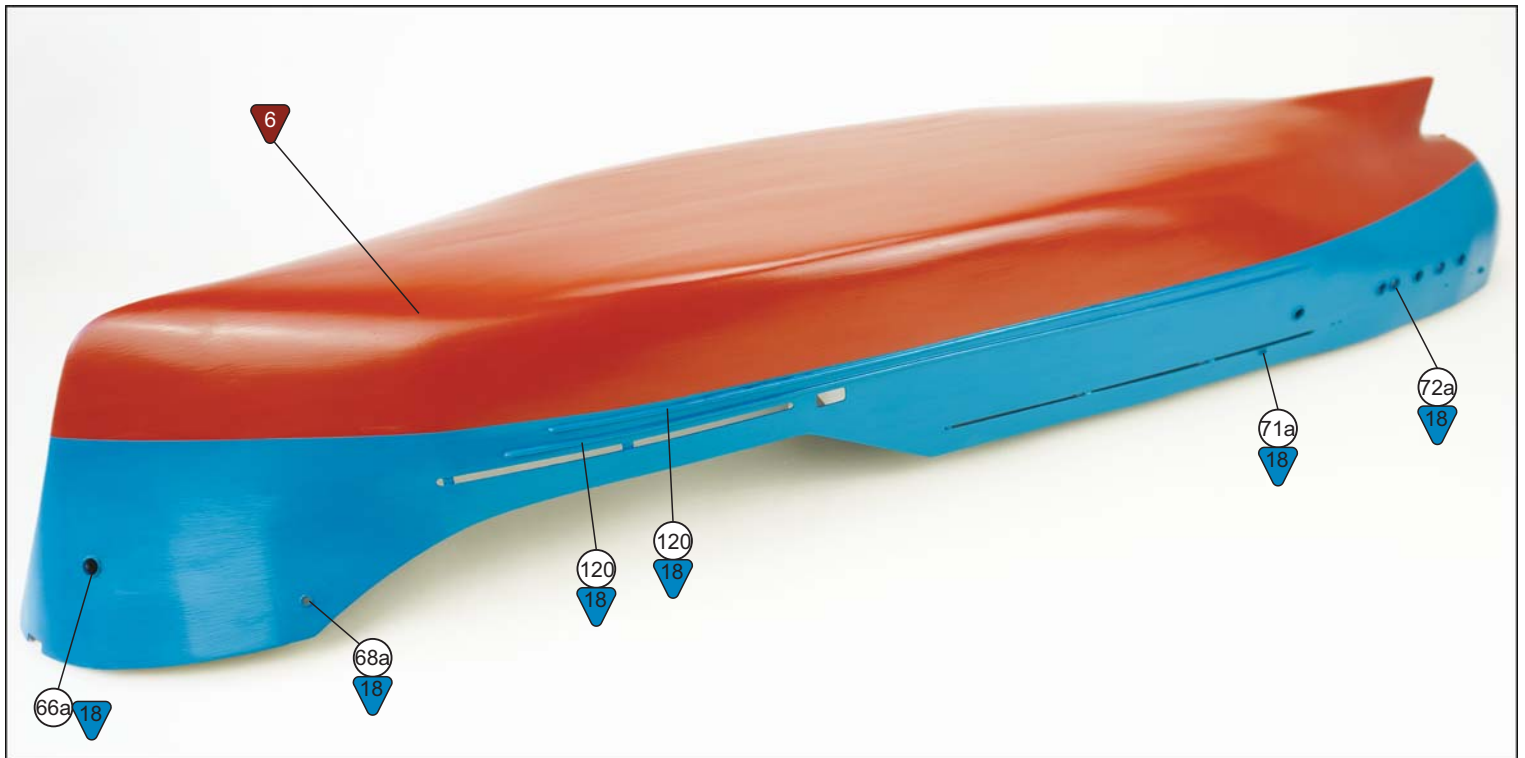
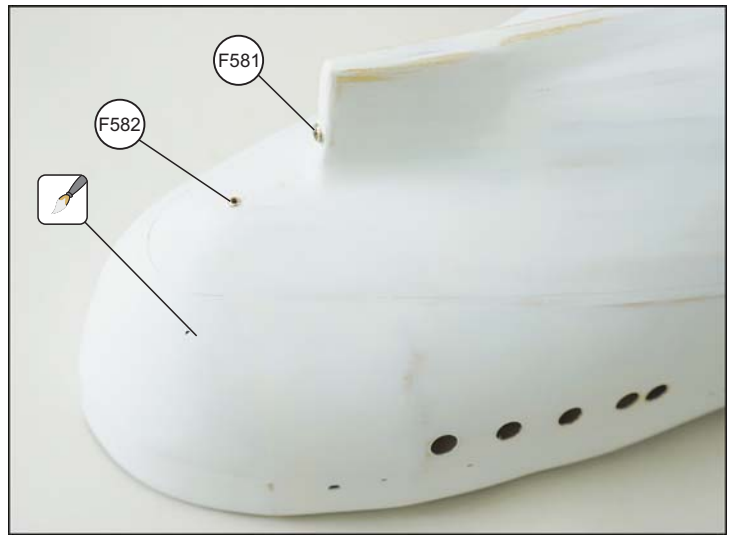
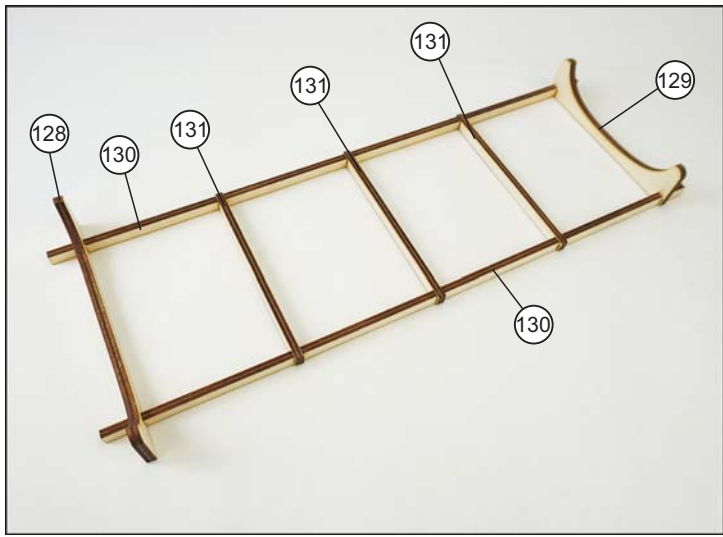

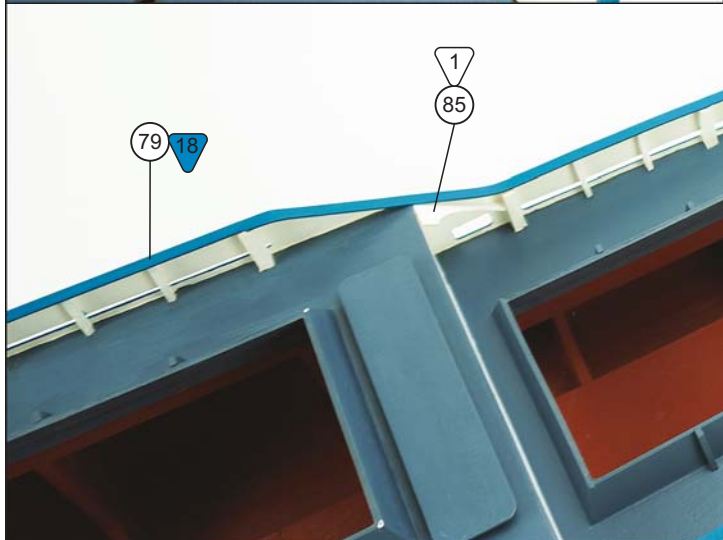
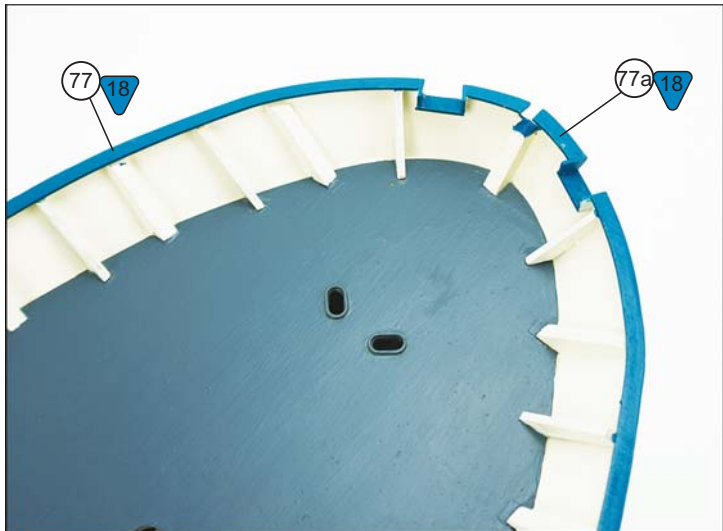
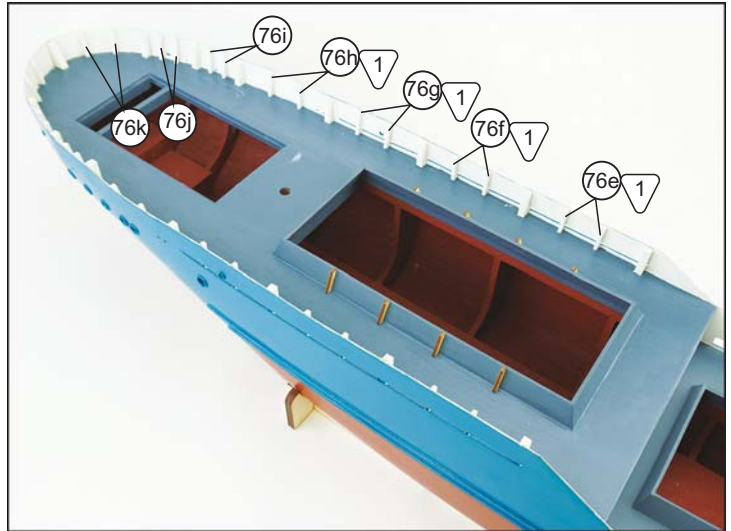
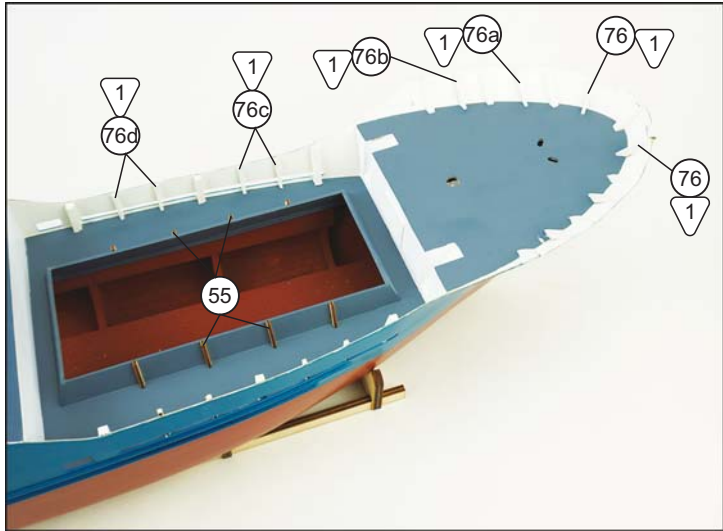
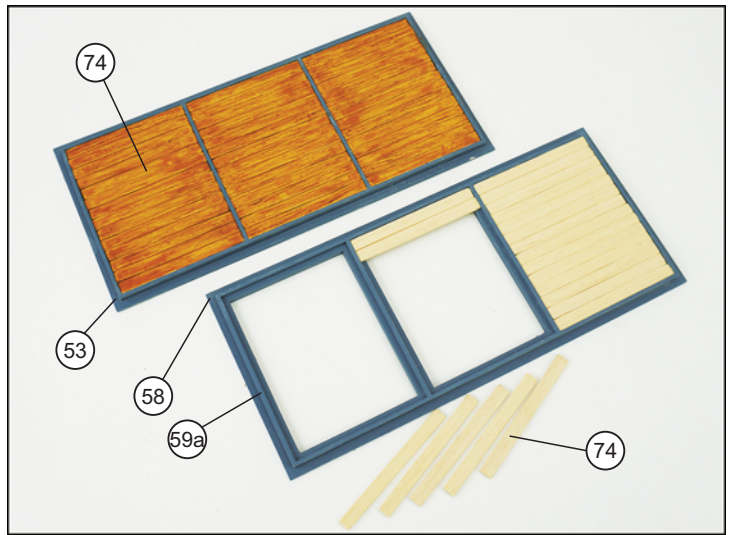
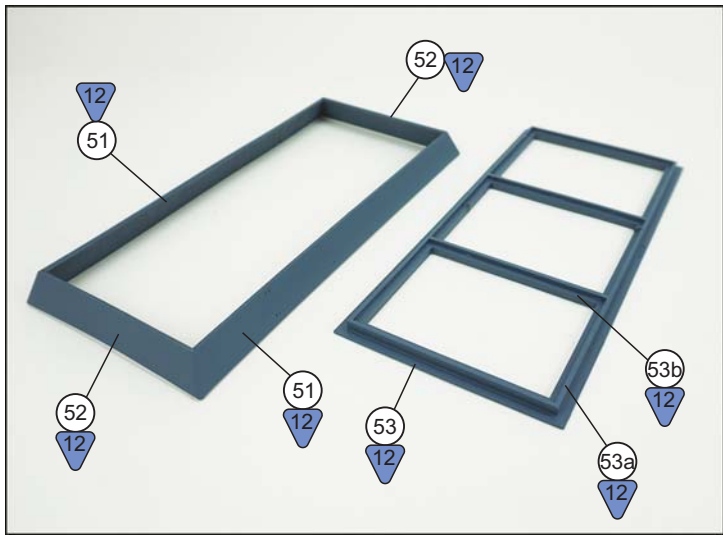

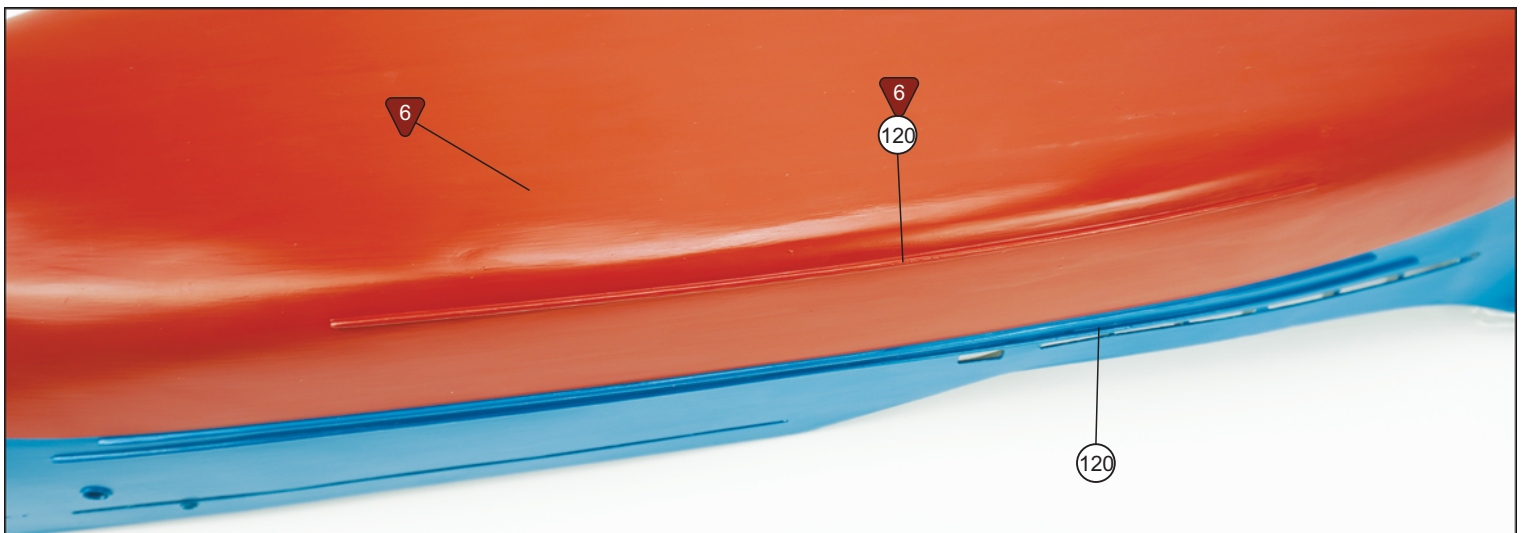
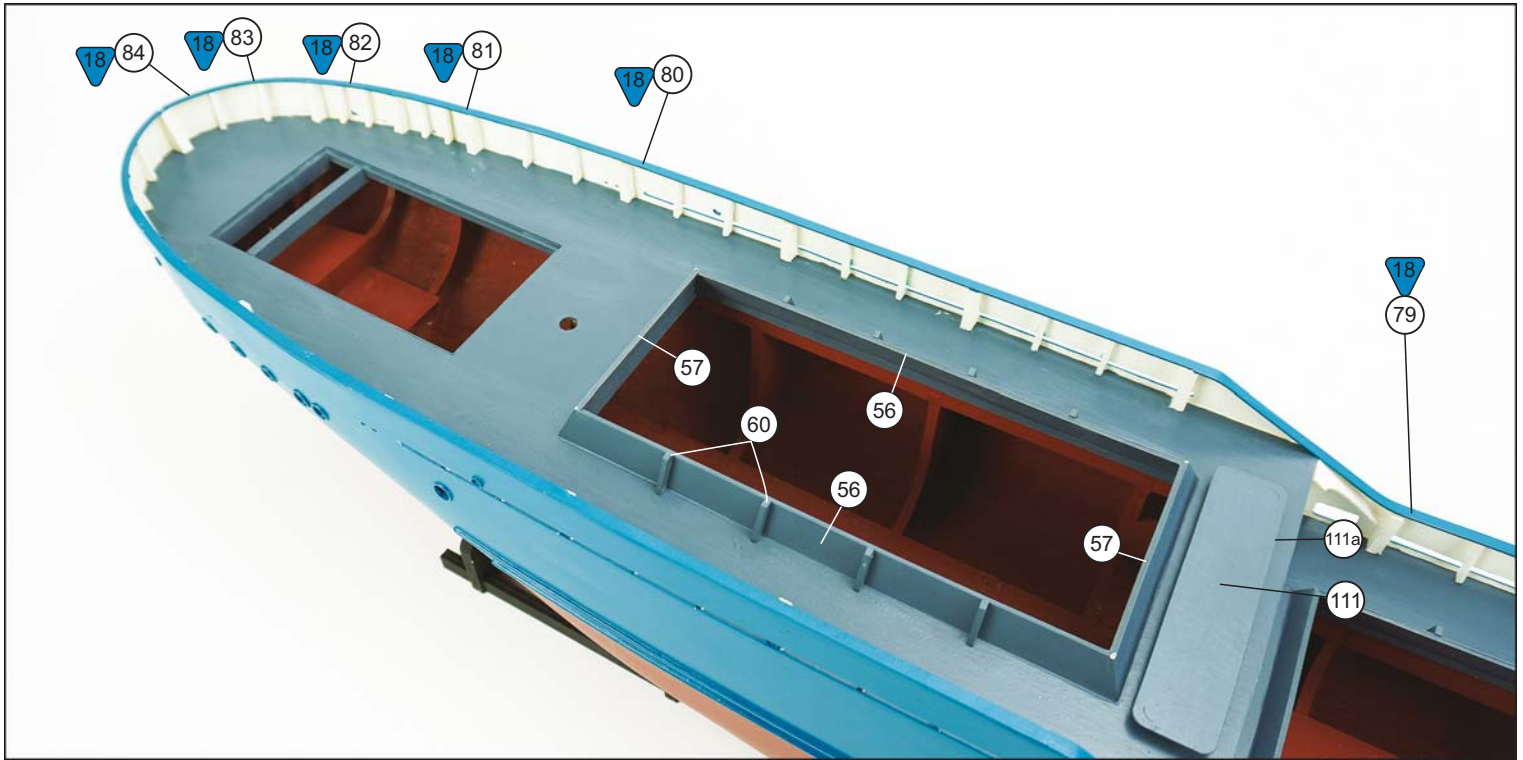

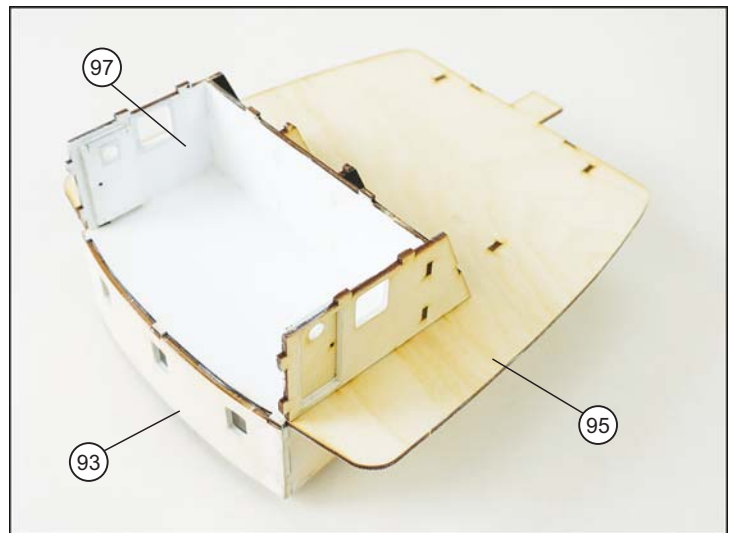
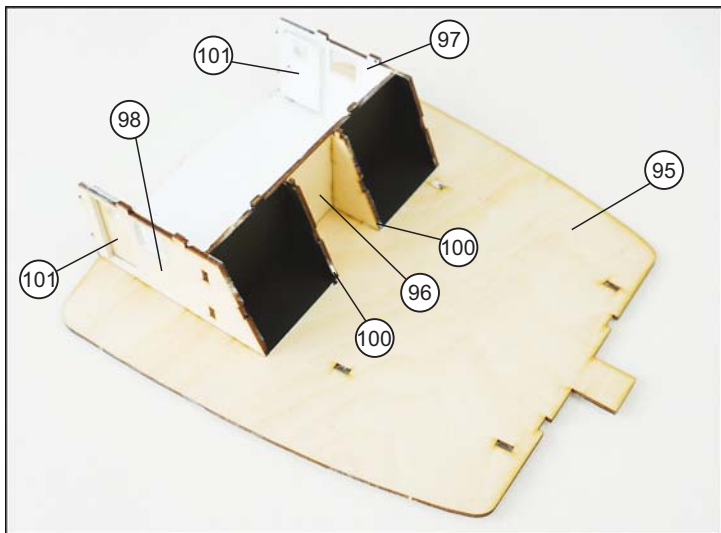
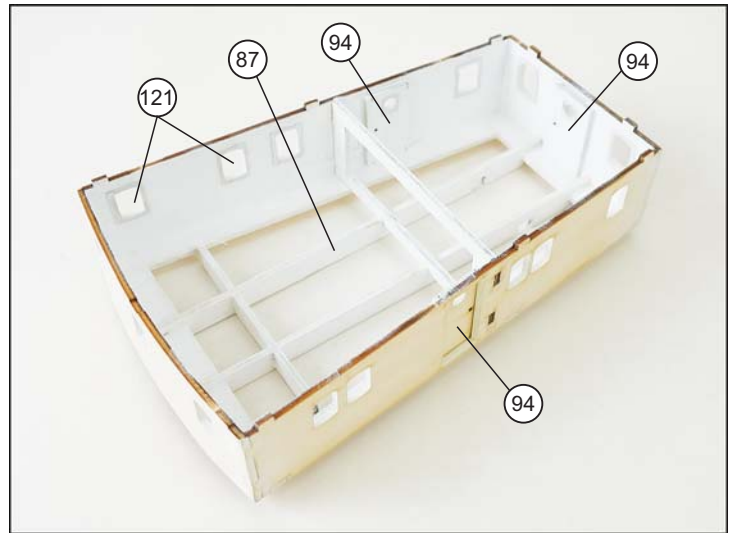
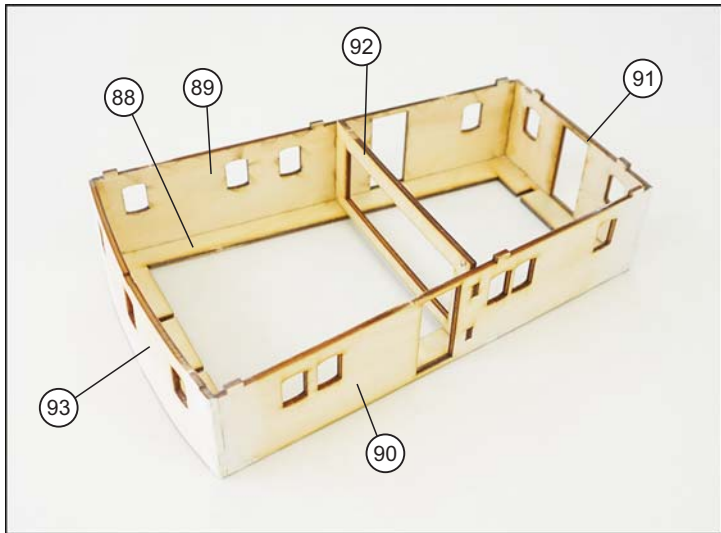
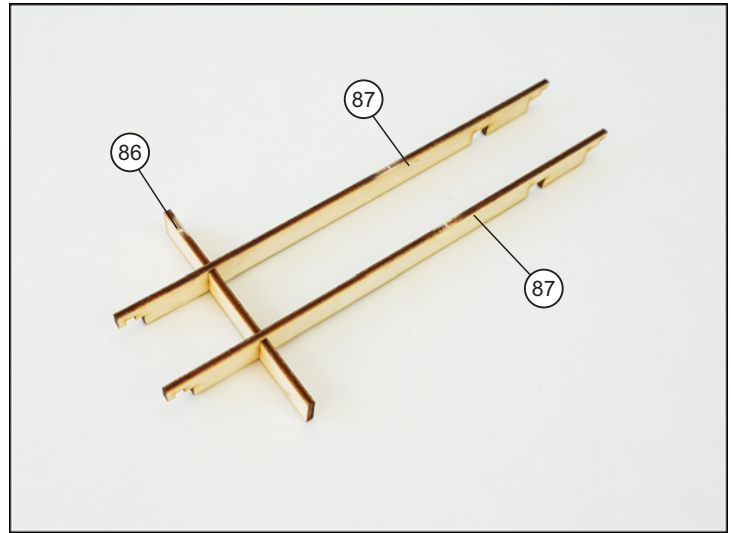
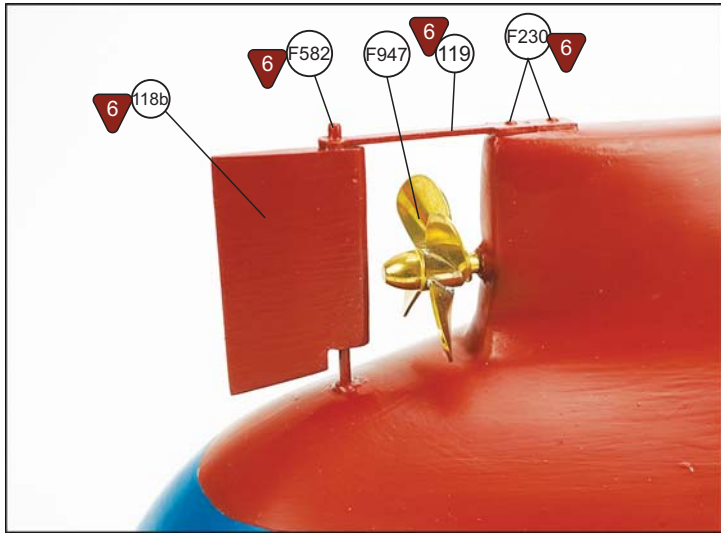
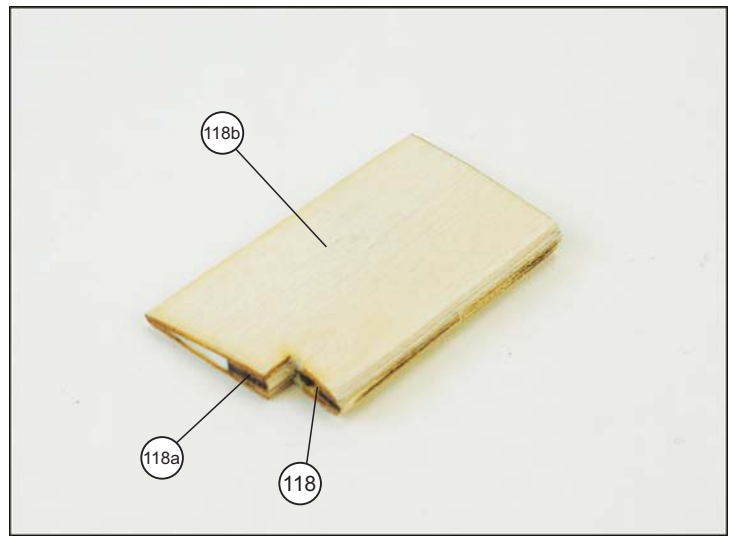
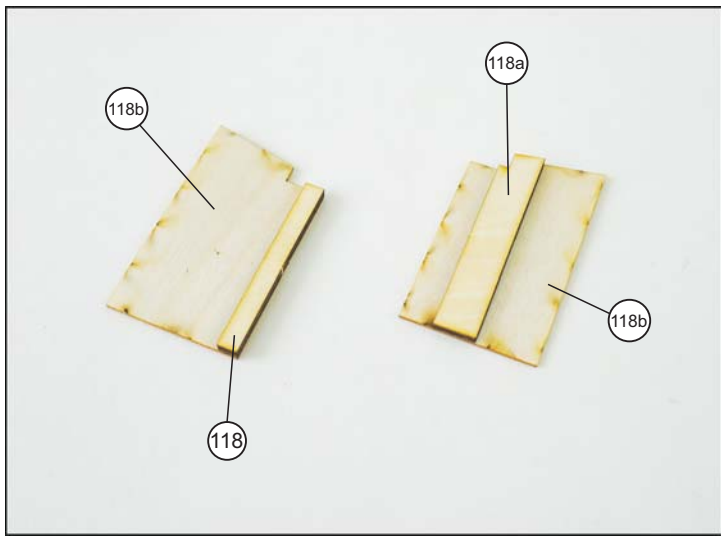

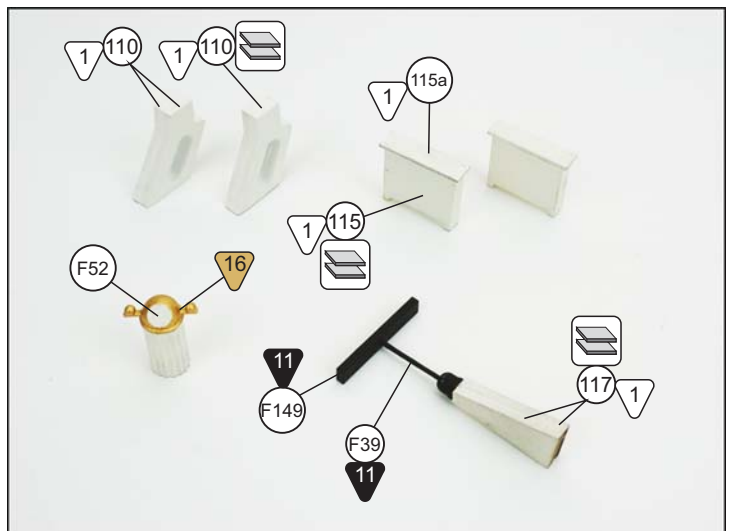
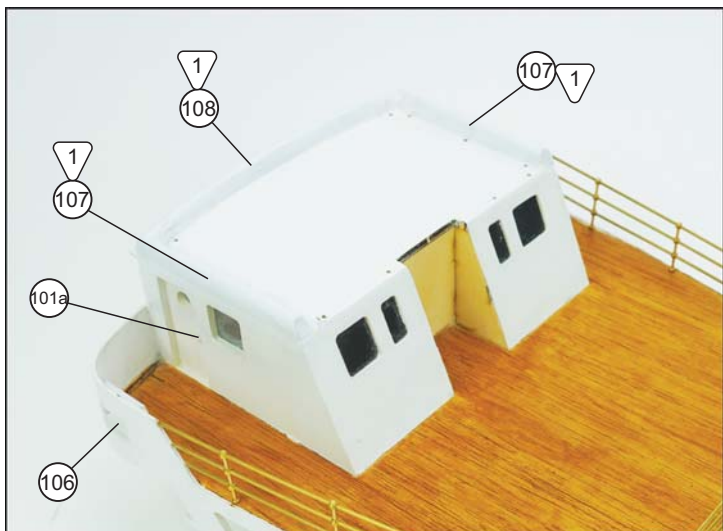
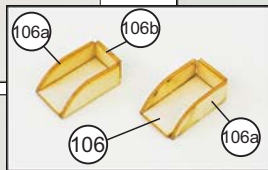
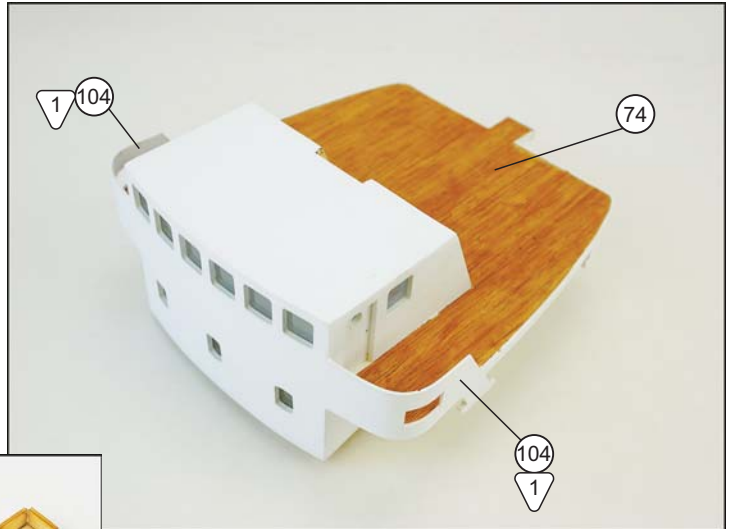
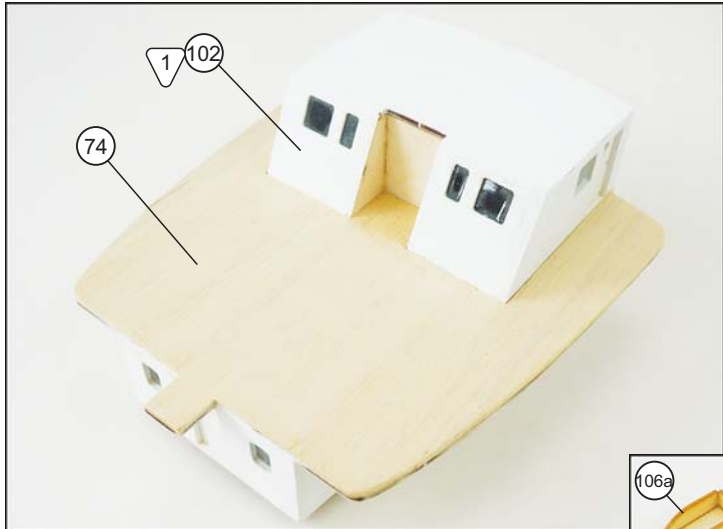
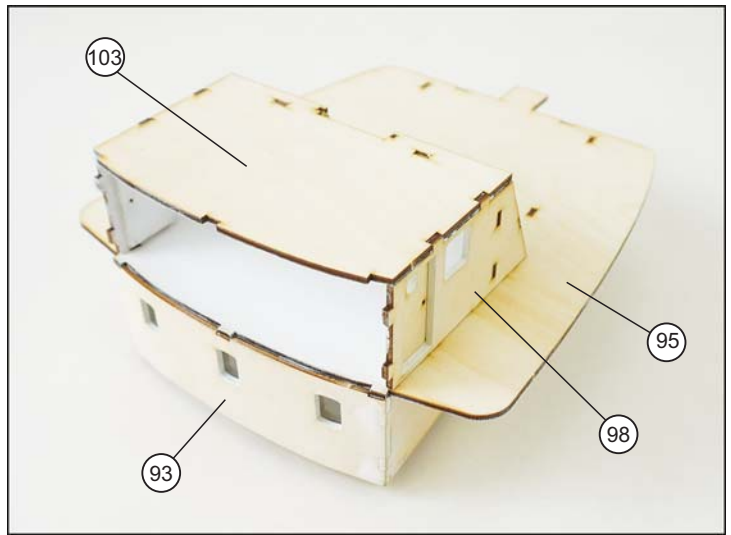
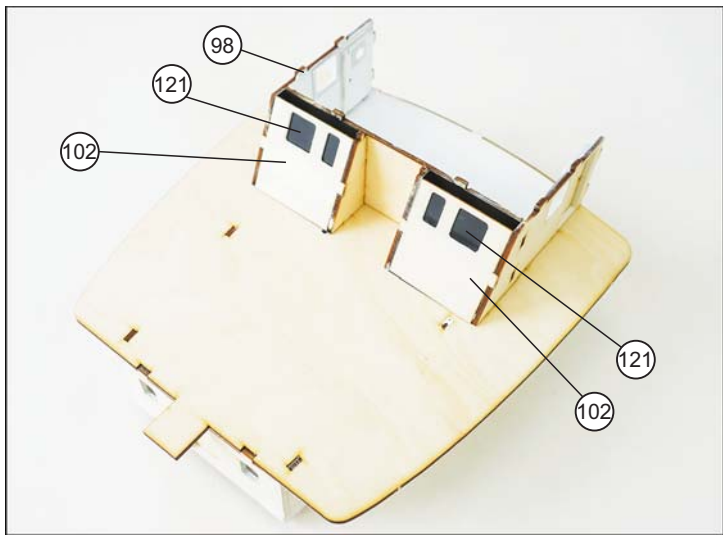

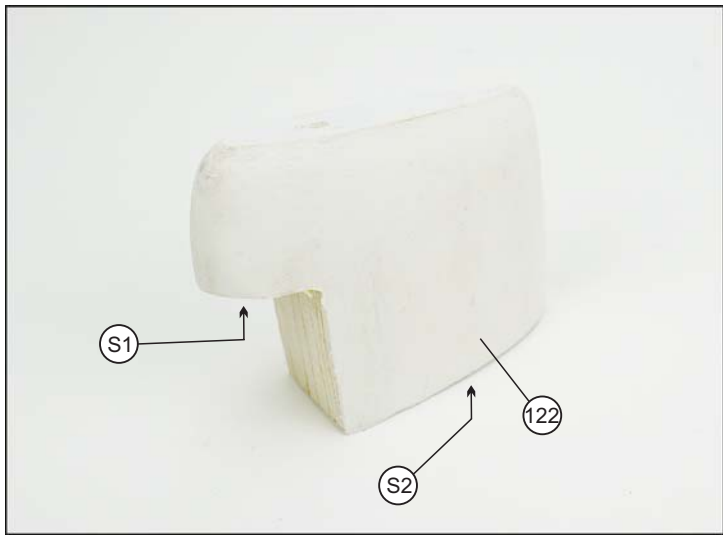

Template for chimney shape

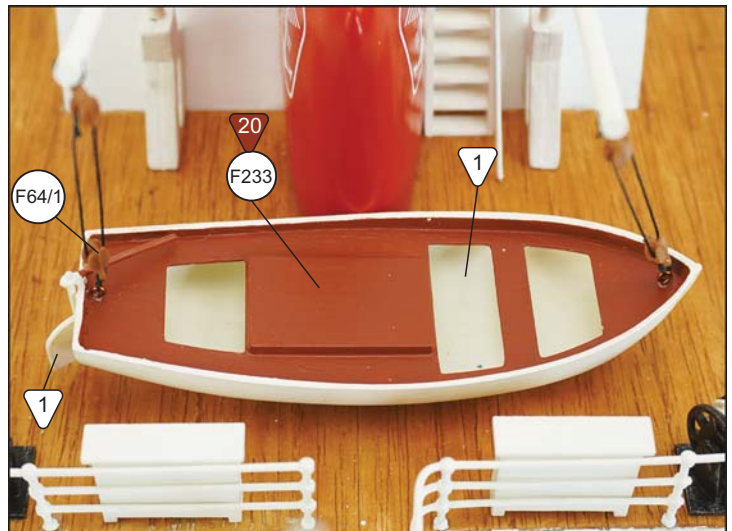
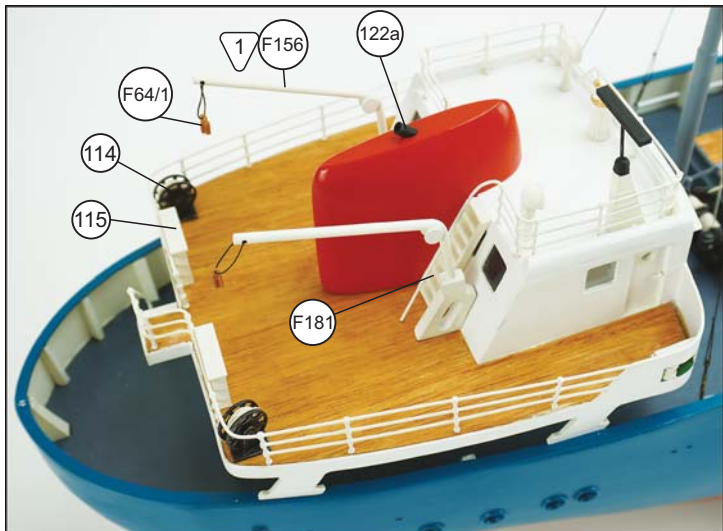
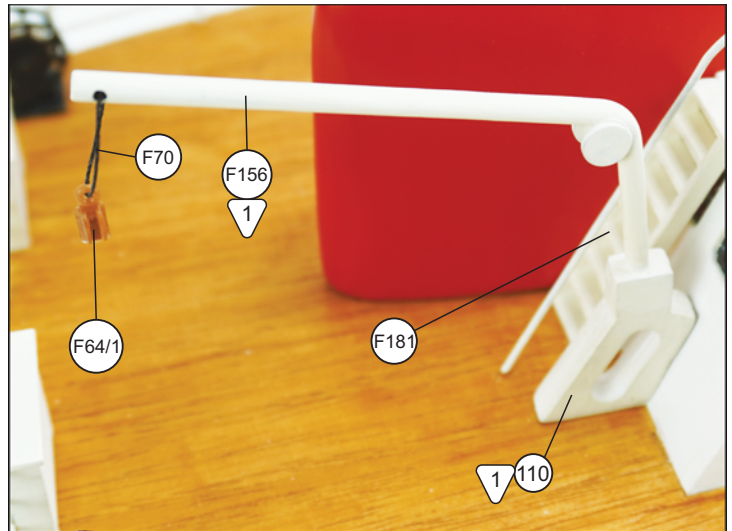
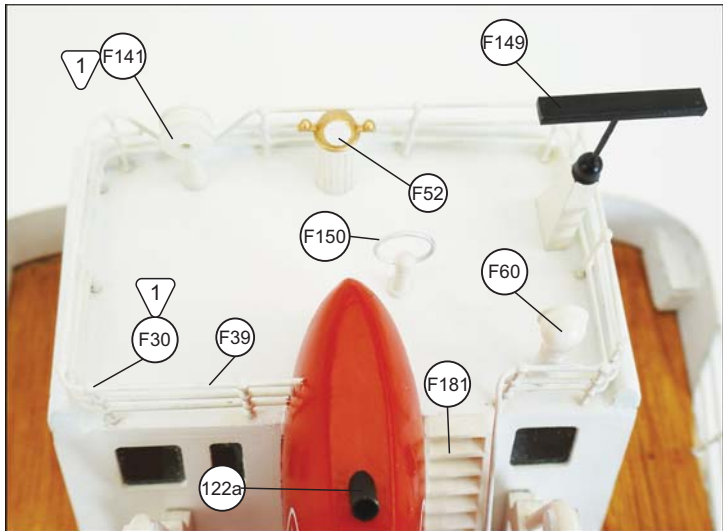
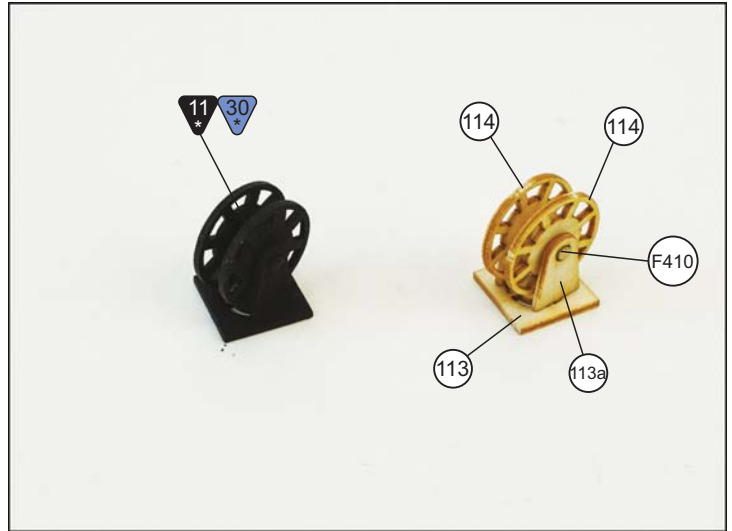
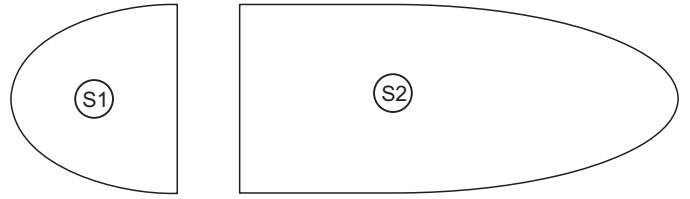

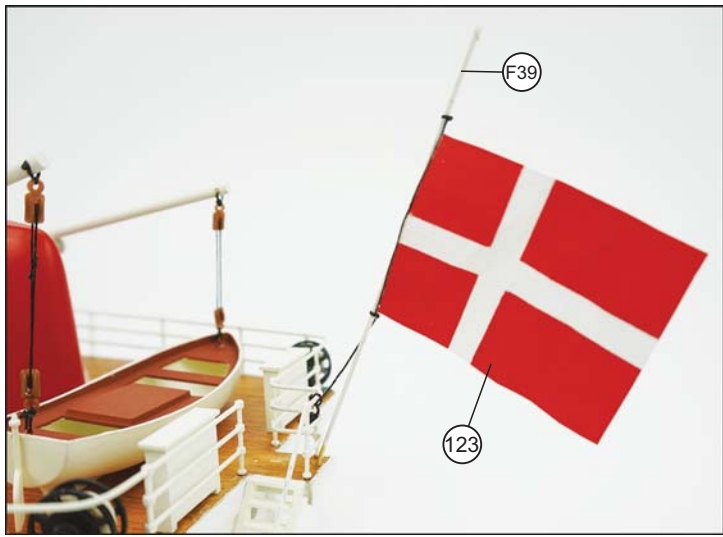

Flag size template

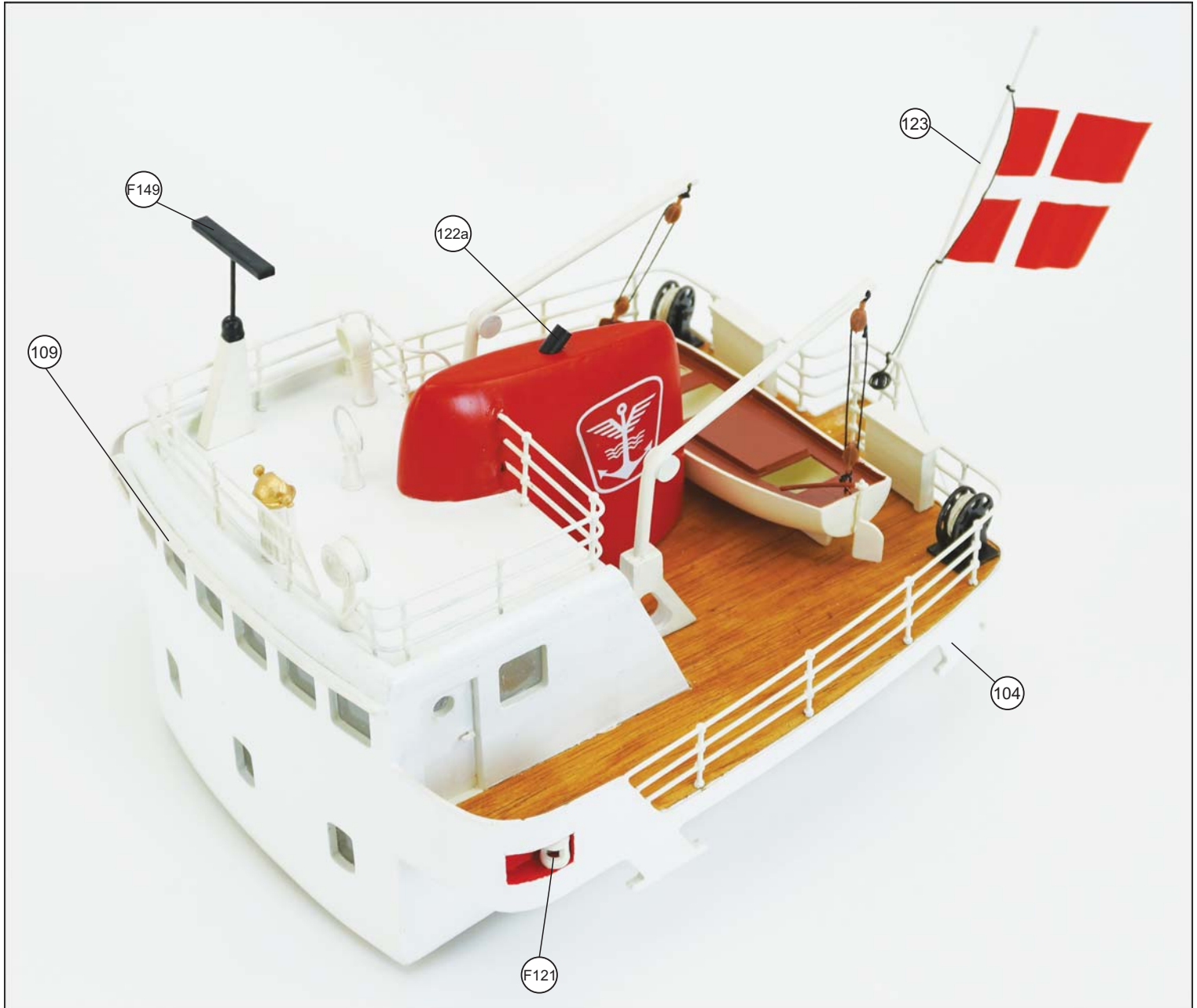
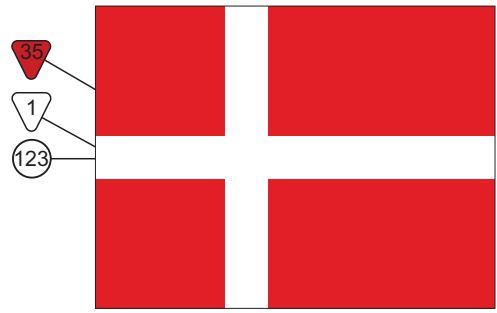

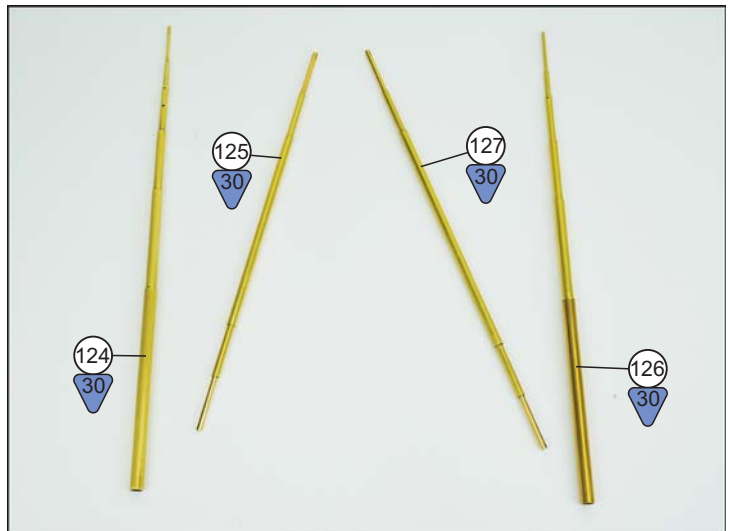
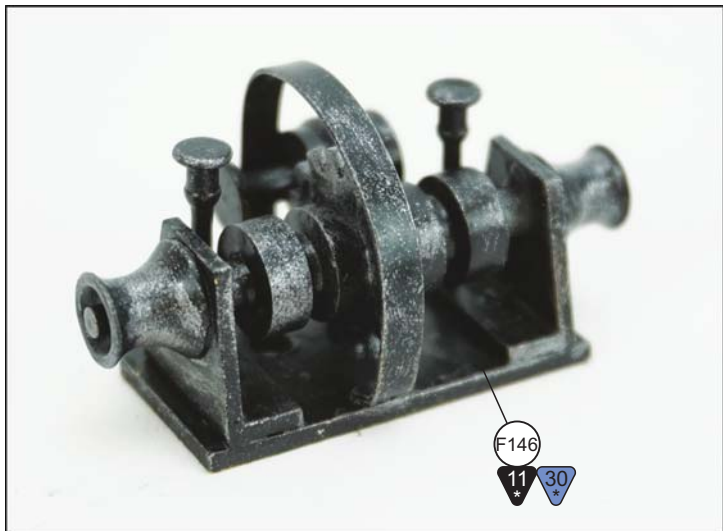
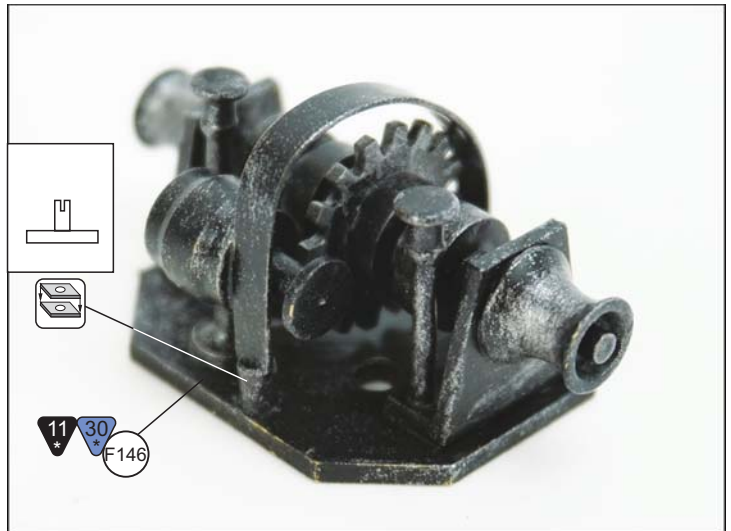
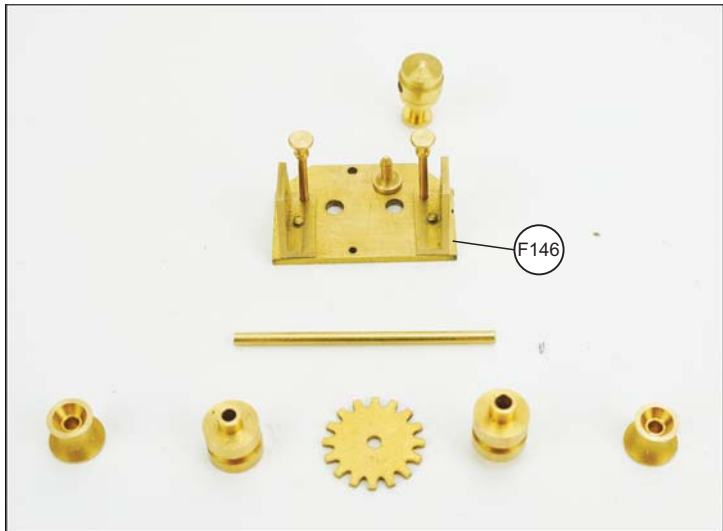
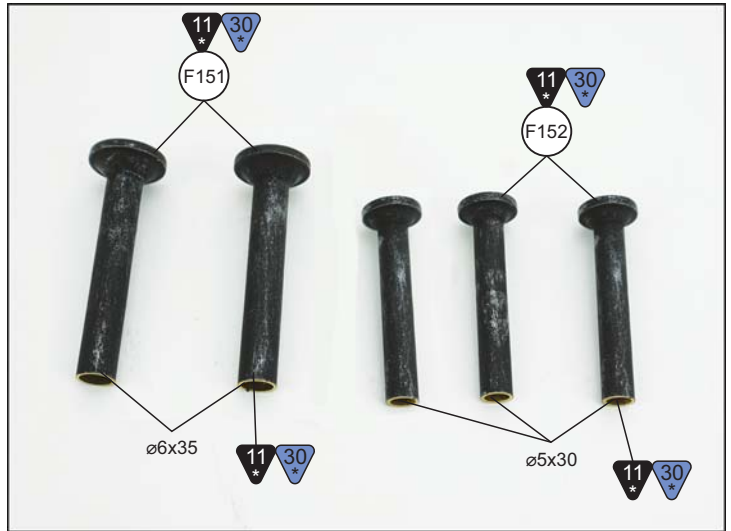
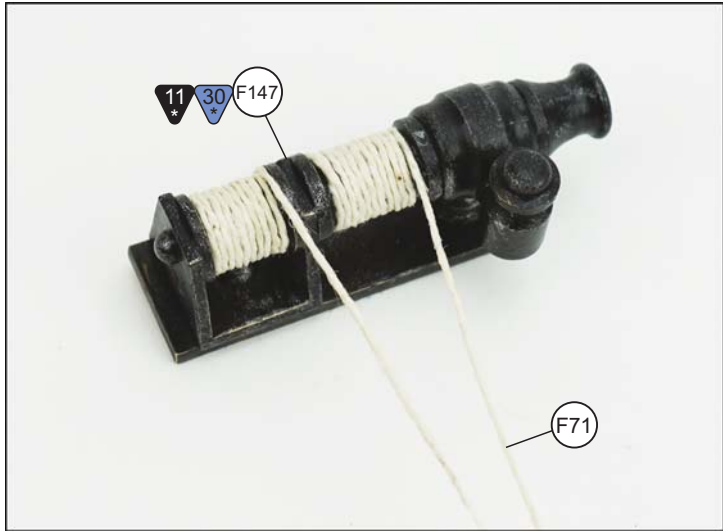
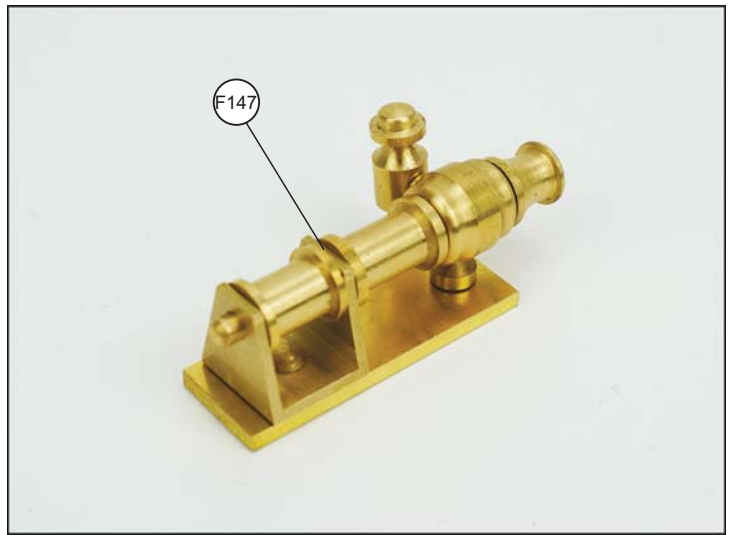

~14~

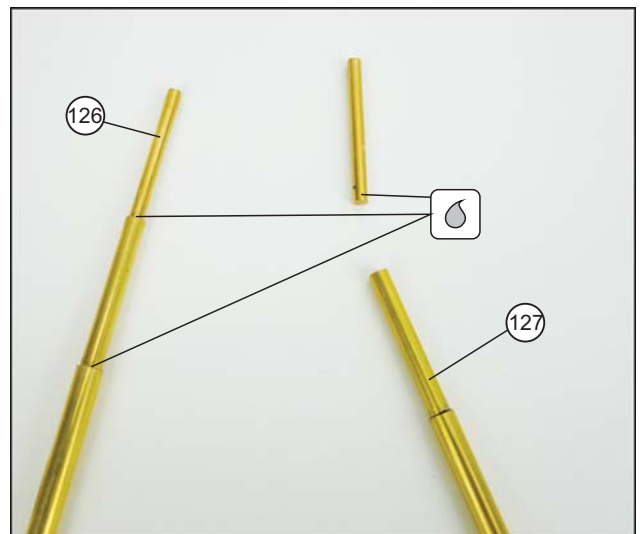
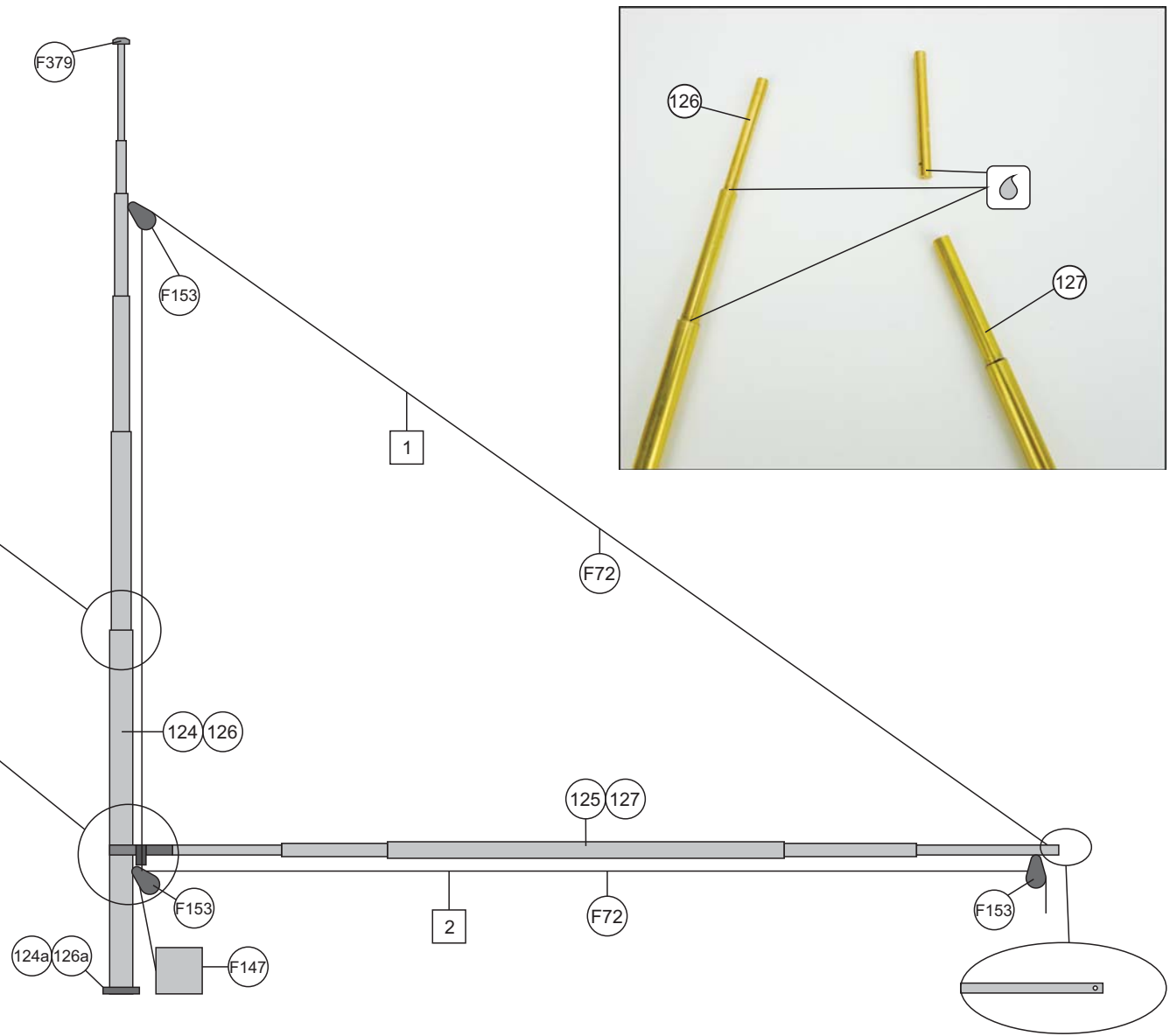
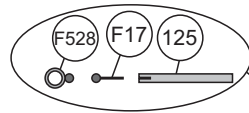
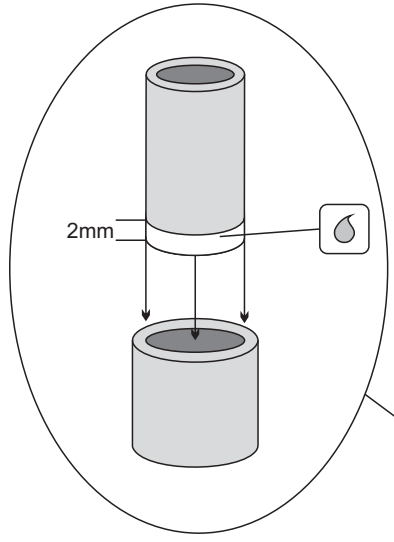
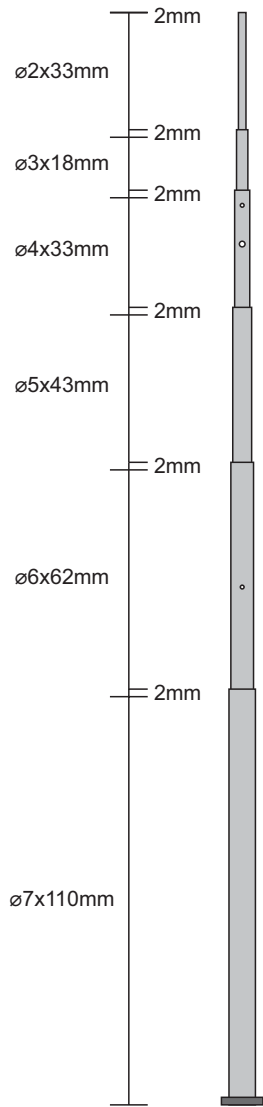

MASTS AND BOOMS

Parts: 124 and 125, 126 and 127

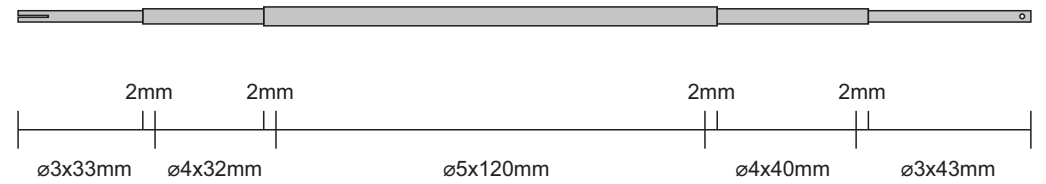

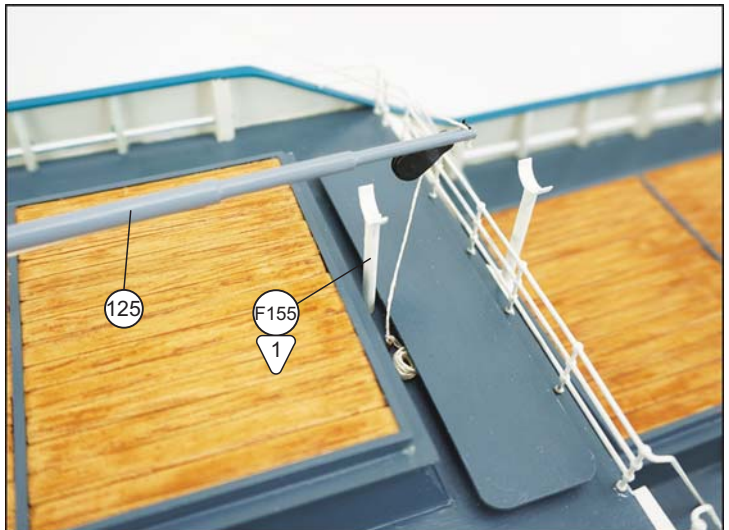
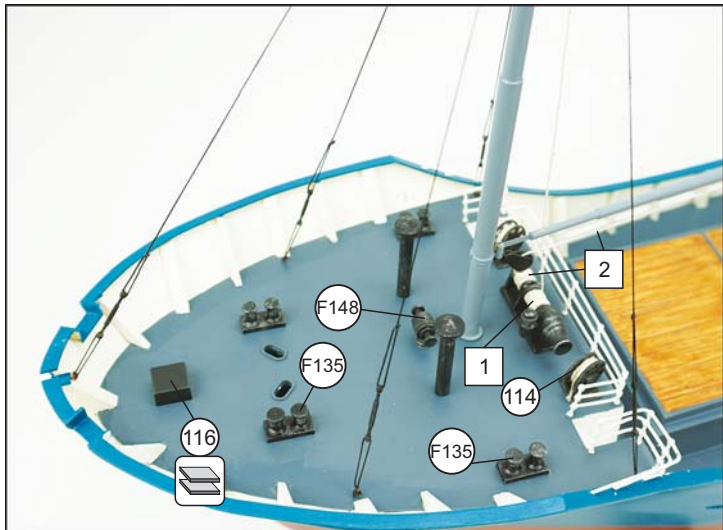
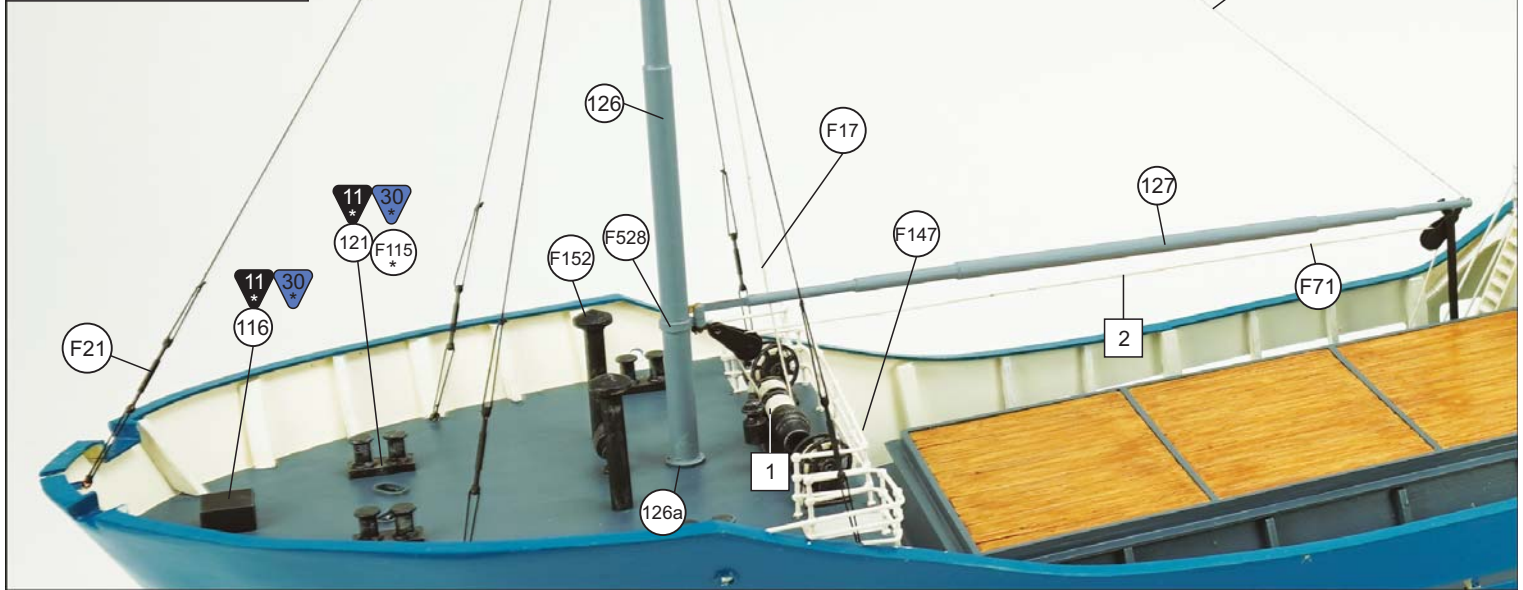
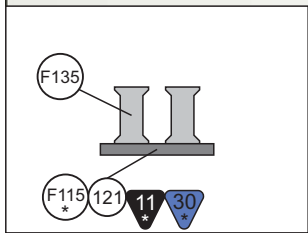
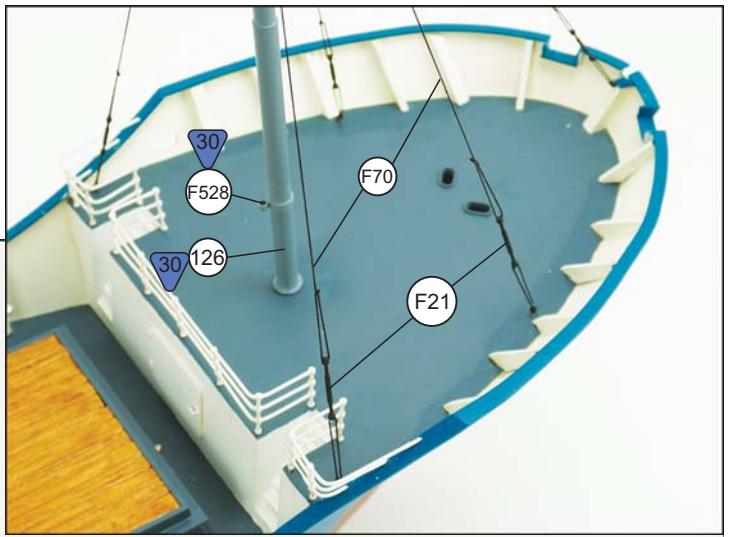
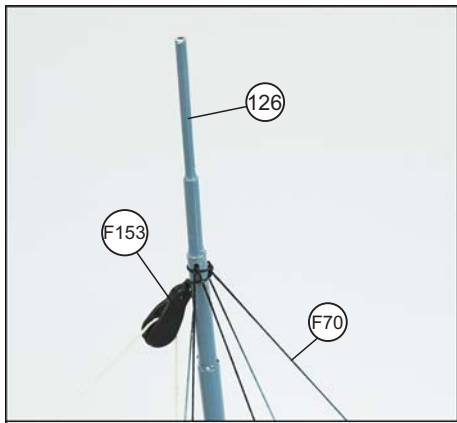

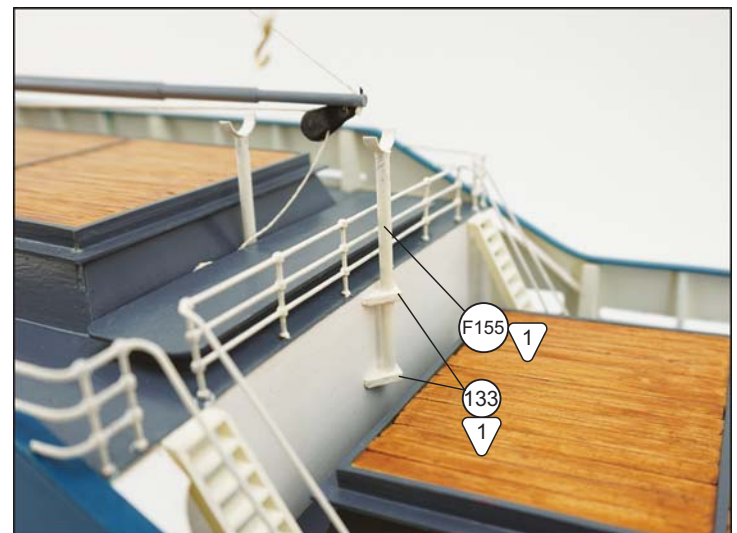
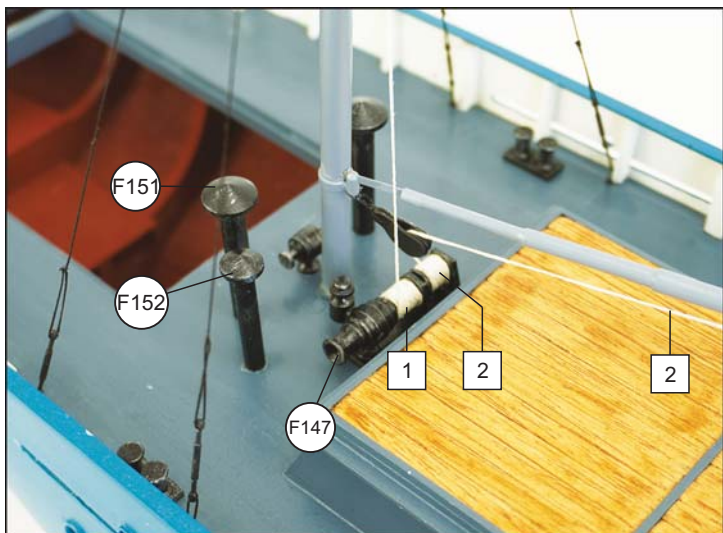
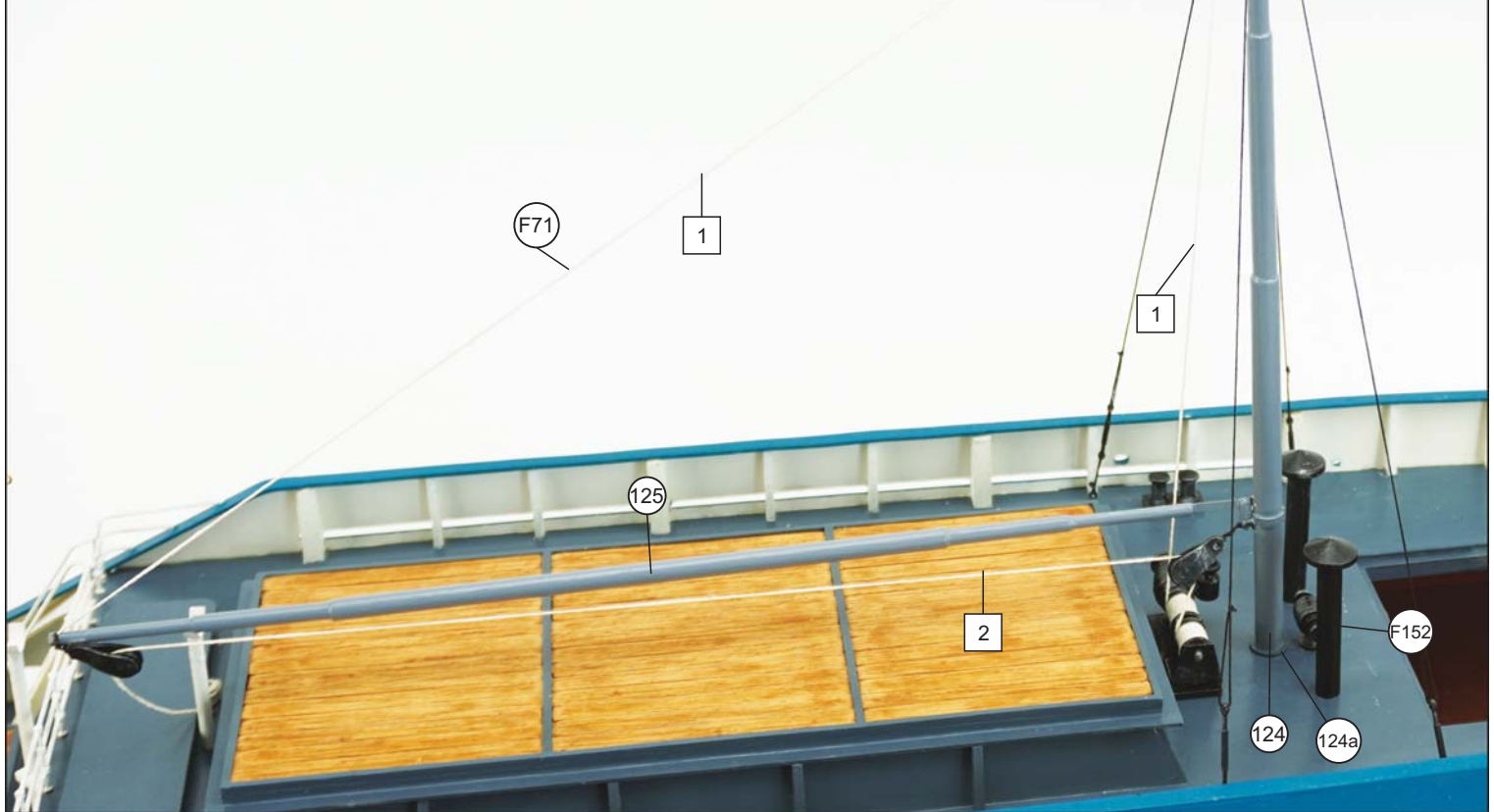
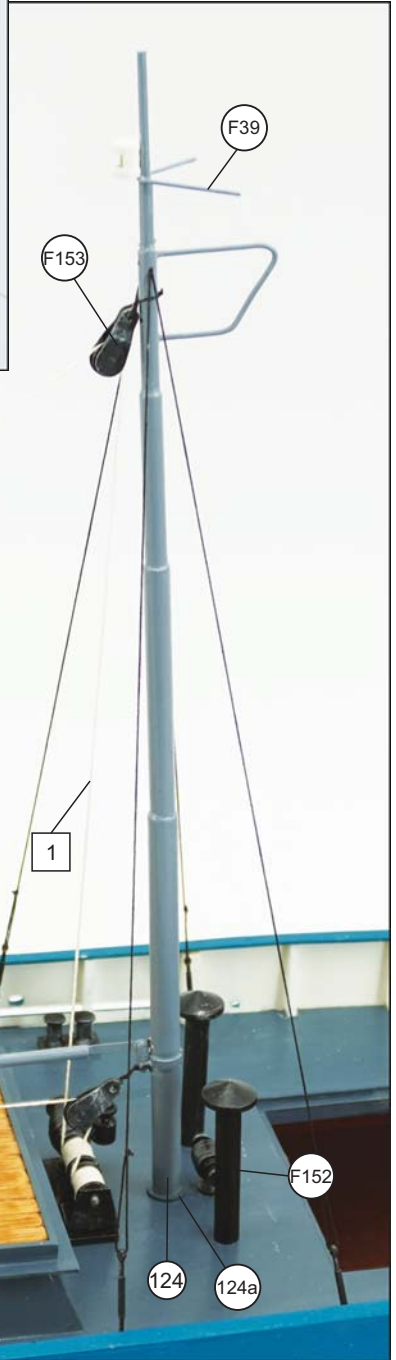
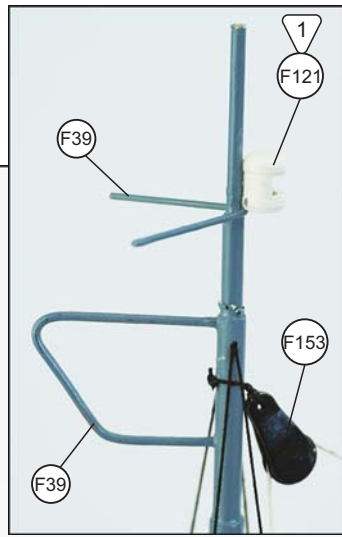
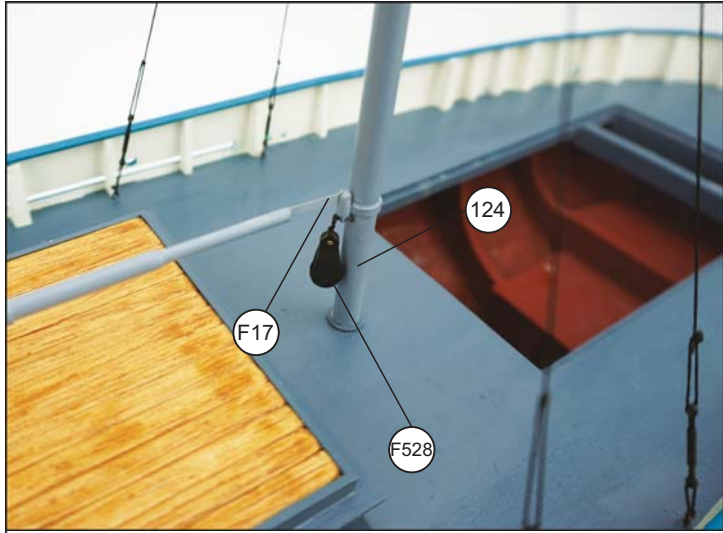

~17~

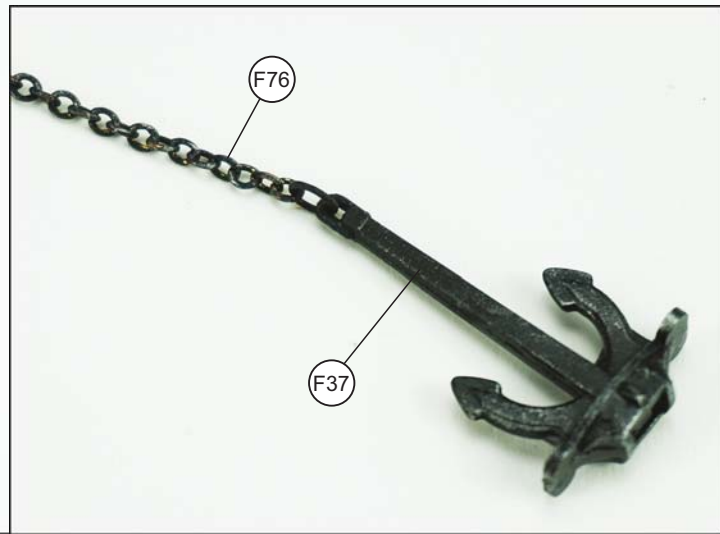
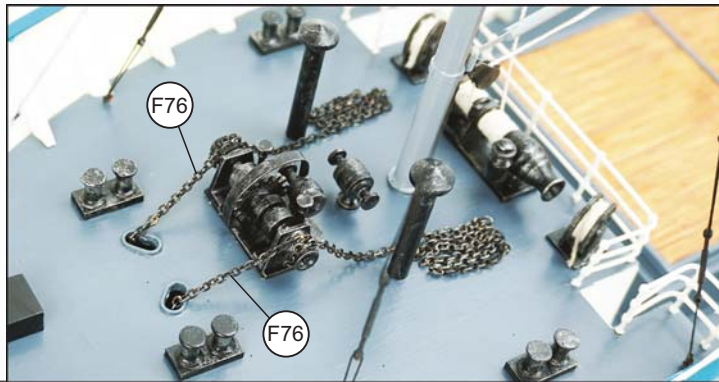

~18~





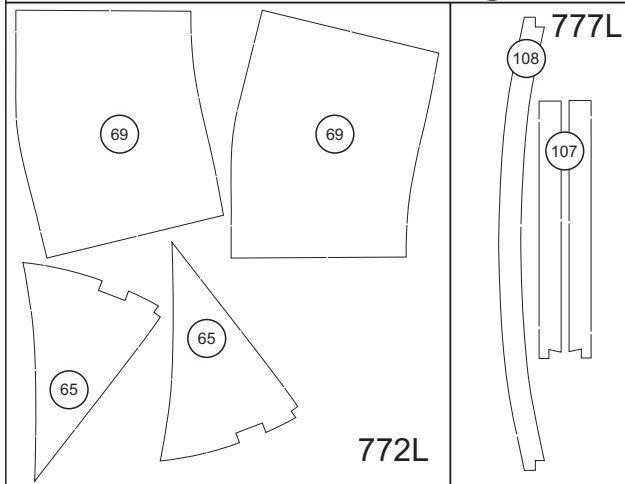
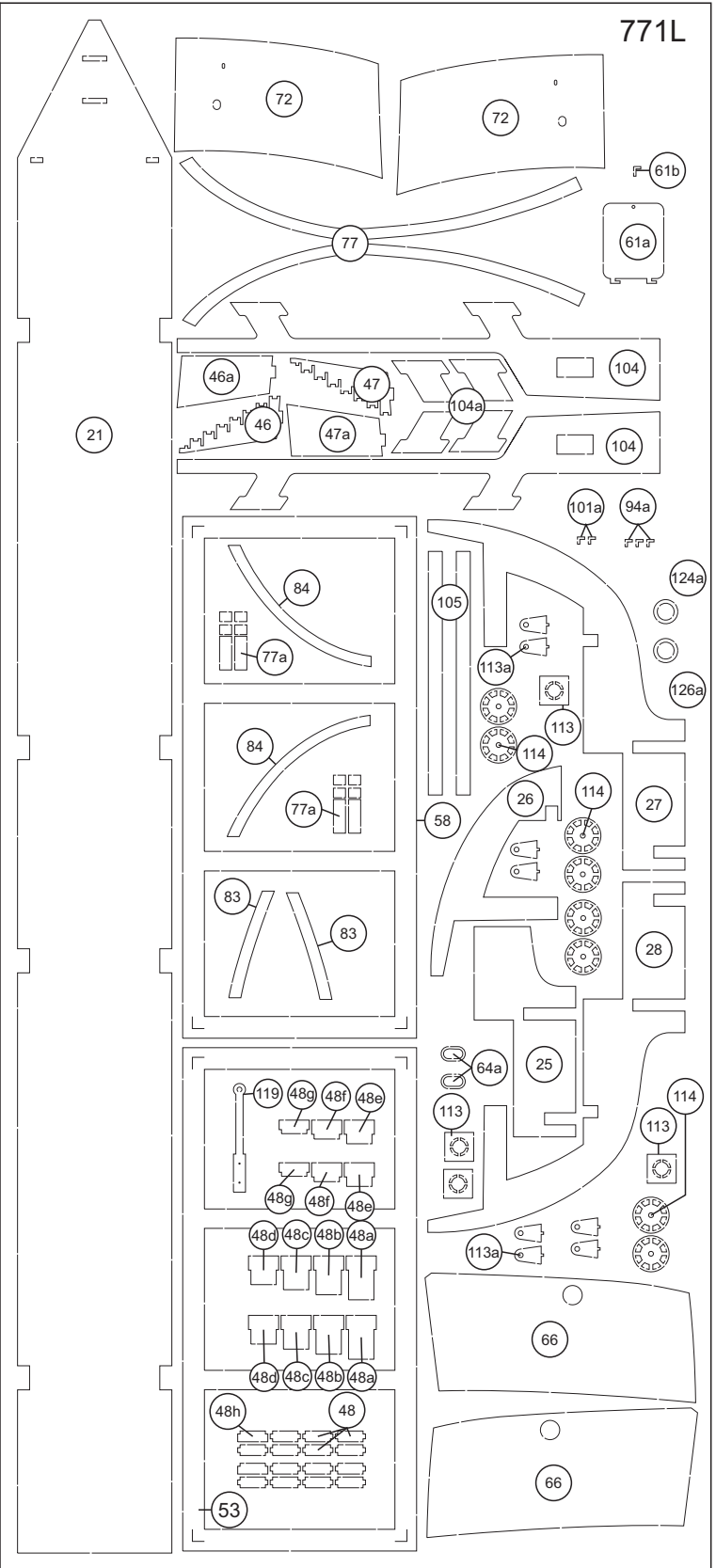
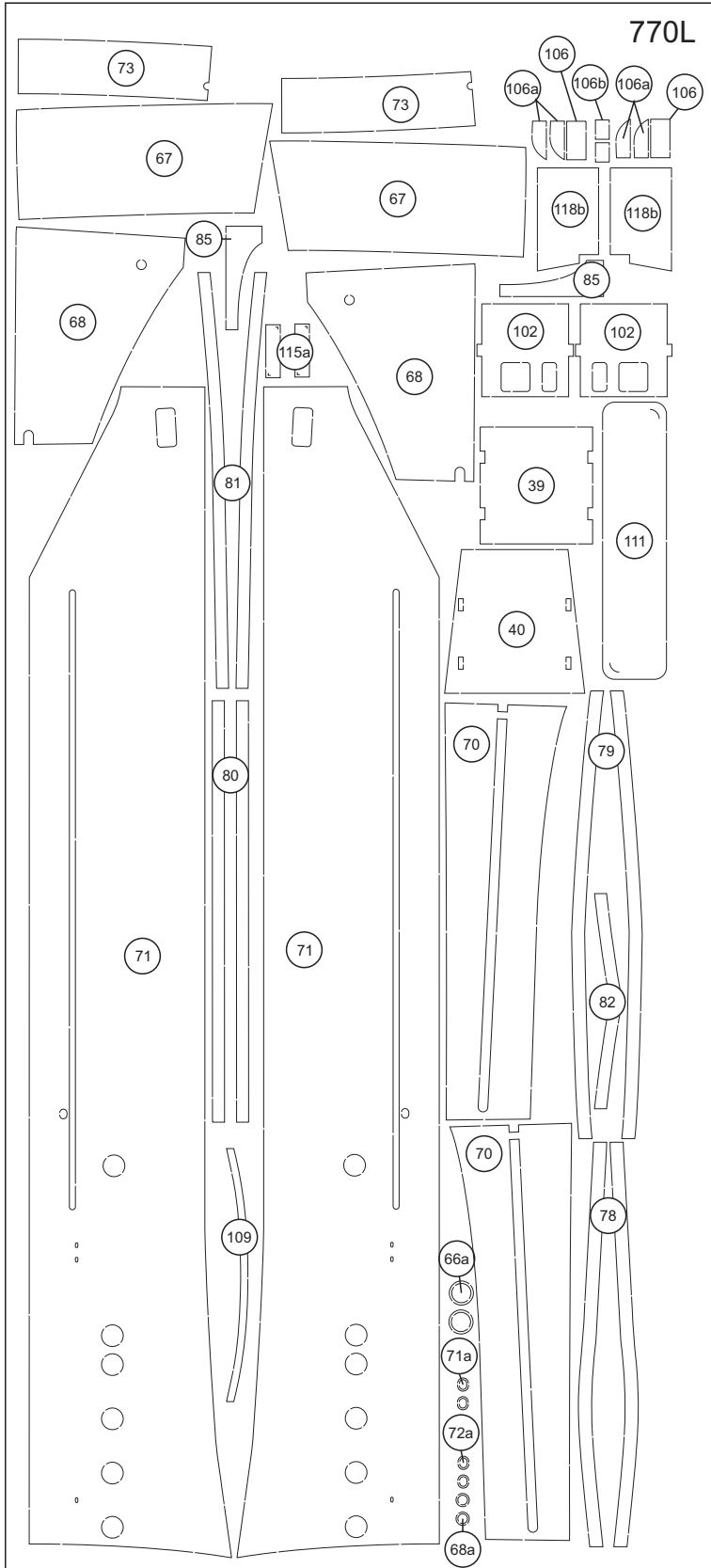

773L

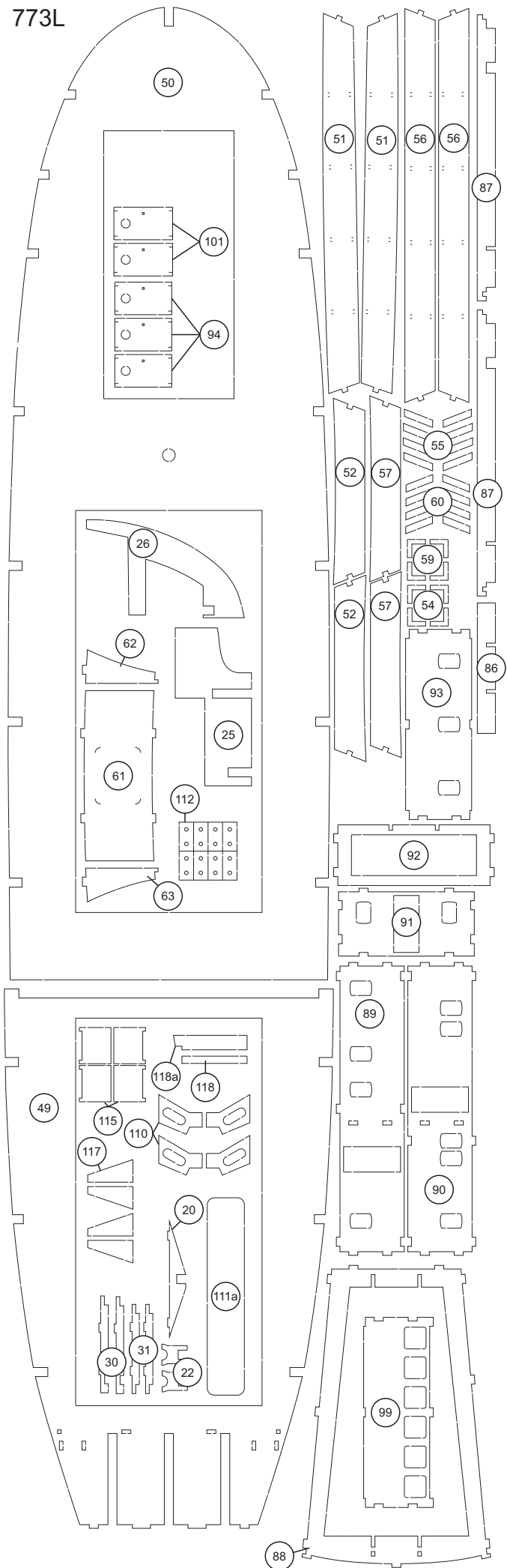

774L

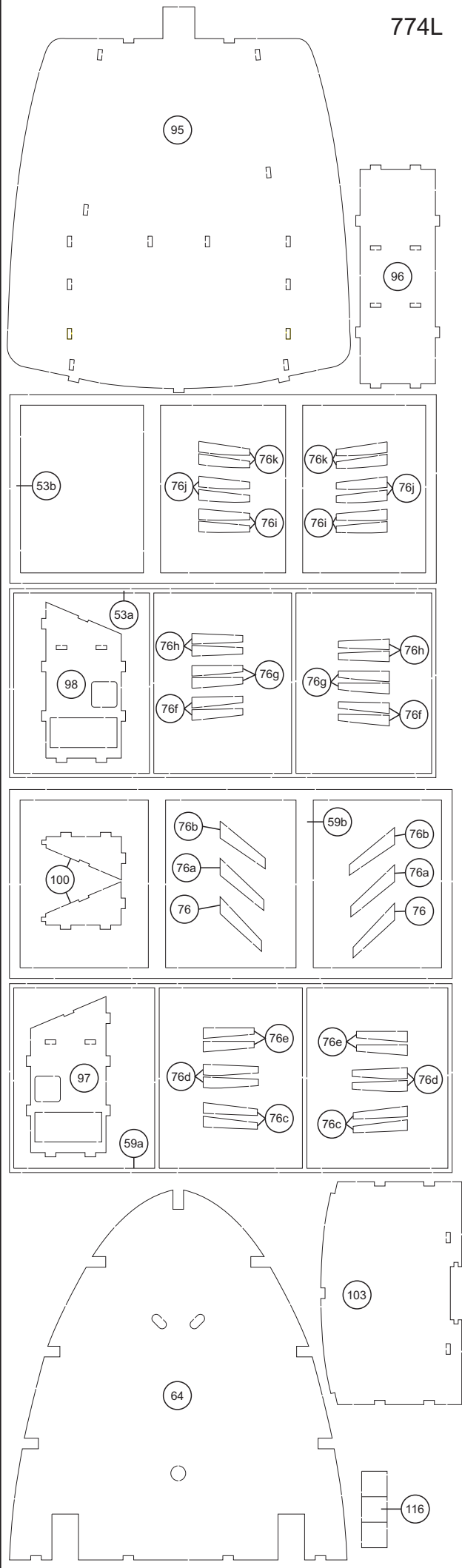

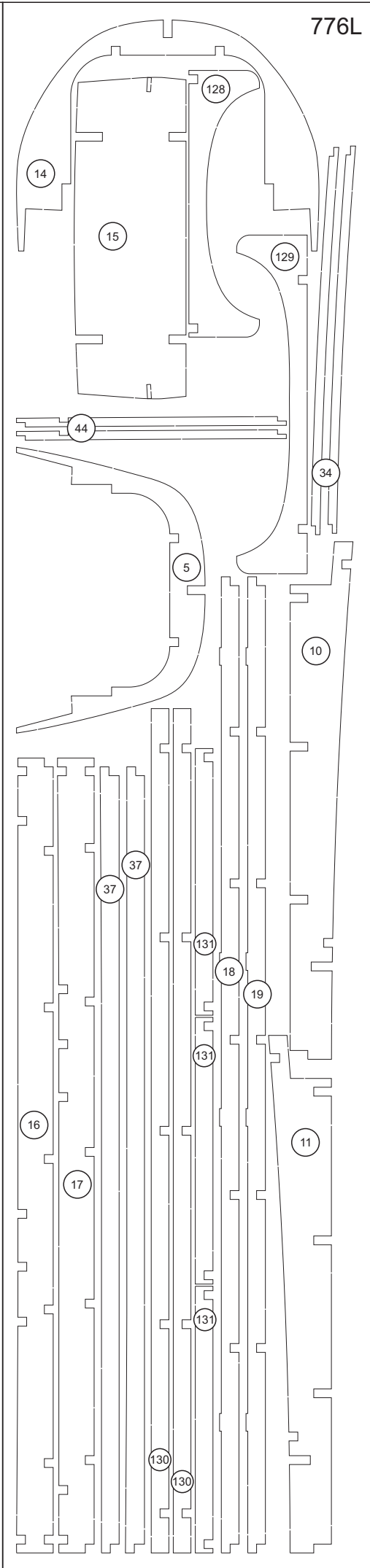
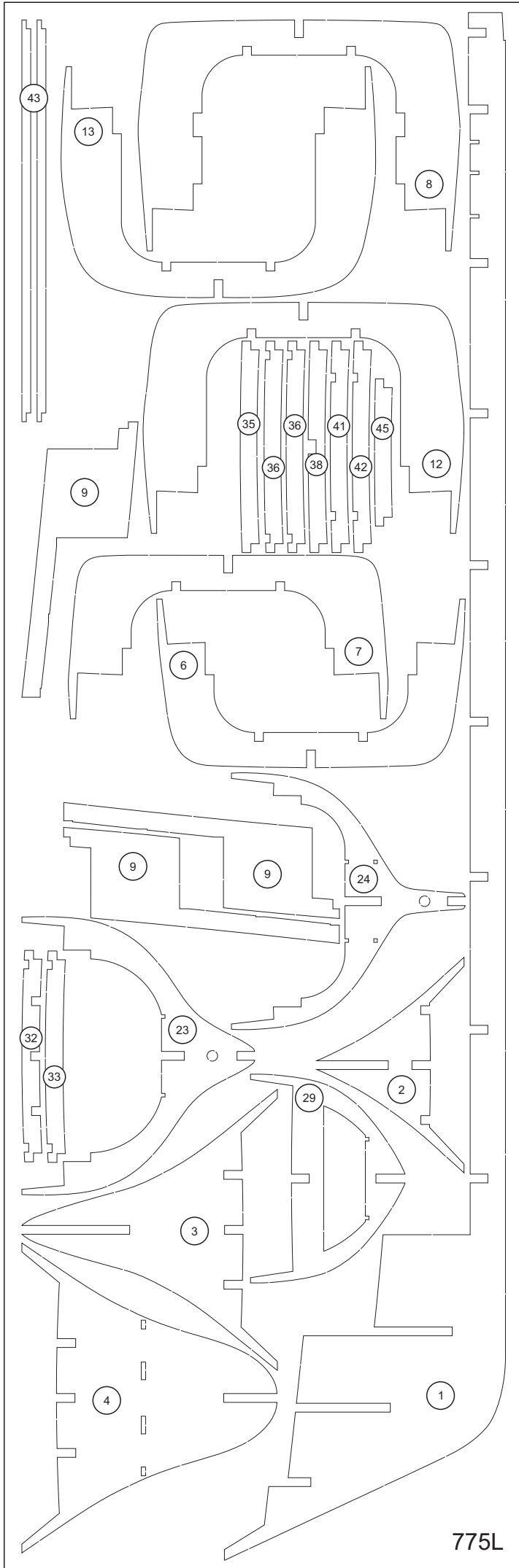

Table of contents for Mercantile Art. No. 424

Antal	Nummer	Dimensions	Material	Found in	DK	GB	D	F	NL
1	1	5 mm x-veneér	775L	LAS	Kølstykke	Keel	Kiel	Cale	Kiel
1	2	5 mm x-veneér	775L	LAS	Spanter	Frame	Spanten	Couples	Spanter
1	3	5 mm x-veneér	775L	LAS	Spanter	Frame	Spanten	Couples	Spanter
1	4	5 mm x-veneér	775L	LAS	Spanter	Frame	Spanten	Couples	Spanter
1	5	5 mm x-veneér	776L	LAS	Spanter	Frame	Spanten	Couples	Spanter
1	6	5 mm x-veneér	775L	LAS	Spanter	Frame	Spanten	Couples	Spanter
1	7	5 mm x-veneér	775L	LAS	Spanter	Frame	Spanten	Couples	Spanter
1	8	5 mm x-veneér	775L	LAS	Spanter	Frame	Spanten	Couples	Spanter
3	9	5 mm x-veneér	775L	LAS	Spanter	Frame	Spanten	Couples	Spanter
1	10	5 mm x-veneér	776L	LAS	Spanter	Frame	Spanten	Couples	Spanter
1	11	5 mm x-veneér	776L	LAS	Spanter	Frame	Spanten	Couples	Spanter
1	12	5 mm x-veneér	775L	LAS	Spanter	Frame	Spanten	Couples	Spanter
1	13	5 mm x-veneér	775L	LAS	Spanter	Frame	Spanten	Couples	Spanter
1	14	5 mm x-veneér	776L	LAS	Spanter	Frame	Spanten	Couples	Spanter
1	15	5 mm x-veneér	776L	LAS	Spanter	Frame	Spanten	Couples	Spanter
1	16	5 mm x-veneér	776L	LAS	Beslag	Support	Halterung	Support	Haakje
1	17	5 mm x-veneér	776L	LAS	Beslag	Support	Halterung	Support	Haakje
1	18	5 mm x-veneér	776L	LAS	Beslag	Support	Halterung	Support	Haakje
1	19	5 mm x-veneér	776L	LAS	Beslag	Support	Halterung	Support	Haakje
1	20	2 mm x-veneér	773L	LAS	Beslag	Support	Halterung	Support	Haakje
1	21	1 mm x-veneér	771L	LAS	Dæk	Deck	Deck	Pont	Dek
1	22	2 mm x-veneér	773L	LAS	Beslag	Support	Halterung	Support	Haakje
1	23	5 mm x-veneér	775L	LAS	Spanter	Frame	Spanten	Couples	Spanter
1	24	5 mm x-veneér	775L	LAS	Spanter	Frame	Spanten	Couples	Spanter
1	25	1 mm x-veneér	771L	LAS	Spanter	Frame	Spanten	Couples	Spanter
1	25	2 mm x-veneér	773L	LAS	Spanter	Frame	Spanten	Couples	Spanter
1	26	1 mm x-veneér	771L	LAS	Spanter	Frame	Spanten	Couples	Spanter
1	26	2 mm x-veneér	773L	LAS	Spanter	Frame	Spanten	Couples	Spanter
2	27	1 mm x-veneér	771L	LAS	Spanter	Frame	Spanten	Couples	Spanter
1	28	1 mm x-veneér	771L	LAS	Spanter	Frame	Spanten	Couples	Spanter
2	29	5 mm x-veneér	775L	LAS	Spanter	Frame	Spanten	Couples	Spanter
2	30	2 mm x-veneér	773L	LAS	Beslag	Support	Halterung	Support	Haakje
1	31	2 mm x-veneér	773L	LAS	Beslag	Support	Halterung	Support	Haakje
1	32	5 mm x-veneér	775L	LAS	Beslag	Support	Halterung	Support	Haakje
1	33	5 mm x-veneér	775L	LAS	Beslag	Support	Halterung	Support	Haakje
4	34	5 mm x-veneér	776L	LAS	Beslag	Support	Halterung	Support	Haakje
1	35	5 mm x-veneér	775L	LAS	Beslag	Support	Halterung	Support	Haakje
2	36	5 mm x-veneér	775L	LAS	Beslag	Support	Halterung	Support	Haakje

~23~

Antal	Nummer	Dimensions	Material	Found in	DK	GB	D	F	NL
1	37	5 mm x-veneér	776L	LAS	Beslag	Support	Halterung	Support	Haakje
1	38	5 mm x-veneér	775L	LAS	Beslag	Support	Halterung	Support	Haakje
1	39	1 mm x-veneér	770L	LAS	Dæk	Deck	Deck	Pont	Dek
1	40	1 mm x-veneér	770L	LAS	Dæk	Deck	Deck	Pont	Dek
1	41	5 mm x-veneér	775L	LAS	Beslag	Support	Halterung	Support	Haakje
1	42	5 mm x-veneér	775L	LAS	Beslag	Support	Halterung	Support	Haakje
1	43	5 mm x-veneér	775L	LAS	Beslag	Support	Halterung	Support	Haakje
1	44	5 mm x-veneér	776L	LAS	Beslag	Support	Halterung	Support	Haakje
1	45	5 mm x-veneér	775L	LAS	Beslag	Support	Halterung	Support	Haakje
1	46	1 mm x-veneér	771L	LAS	Trappe	Stair	Treppe	Escaliers	Trap
1	46a	1 mm x-veneér	771L	LAS	Trappe	Stair	Treppe	Escaliers	Trap
1	47	1 mm x-veneér	771L	LAS	Trappe	Stair	Treppe	Escaliers	Trap
1	47a	1 mm x-veneér	771L	LAS	Trappe	Stair	Treppe	Escaliers	Trap
14	48	1 mm x-veneér	771L	LAS	Trappe	Stair	Treppe	Escaliers	Trap
16	48a – 48h	1 mm x-veneér	771L	LAS	Trappe	Stair	Treppe	Escaliers	Trap
1	49	2 mm x-veneér	773L	LAS	Dæk	Deck	Deck	Pont	Dek
1	50	2 mm x-veneér	773L	LAS	Dæk	Deck	Deck	Pont	Dek
2	51	2 mm x-veneér	773L	LAS	Luge	Hatch	Luke	Éclore	Klep
2	52	2 mm x-veneér	773L	LAS	Luge	Hatch	Luke	Éclore	Klep
1	53	1 mm x-veneér	771L	LAS	Luge	Hatch	Luke	Éclore	Klep
1	53a	2 mm x-veneér	774L	LAS	Luge	Hatch	Luke	Éclore	Klep
1	53b	2 mm x-veneér	774L	LAS	Luge	Hatch	Luke	Éclore	Klep
1	54	2 mm x-veneér	773L	LAS	Luge	Hatch	Luke	Éclore	Klep
1	55	2 mm x-veneér	773L	LAS	Luge	Hatch	Luke	Éclore	Klep
2	56	2 mm x-veneér	773L	LAS	Luge	Hatch	Luke	Éclore	Klep
2	57	2 mm x-veneér	773L	LAS	Luge	Hatch	Luke	Éclore	Klep
1	58	1 mm x-veneér	771L	LAS	Luge	Hatch	Luke	Éclore	Klep
1	59	2 mm x-veneér	773L	LAS	Luge	Hatch	Luke	Éclore	Klep
1	59a	2 mm x-veneér	774L	LAS	Luge	Hatch	Luke	Éclore	Klep
1	59b	2 mm x-veneér	774L	LAS	Luge	Hatch	Luke	Éclore	Klep
1	60	2 mm x-veneér	773L	LAS	Luge	Hatch	Luke	Éclore	Klep
1	61	2 mm x-veneér	773L	LAS	Væg	Wall	Wand	Mur	Muur
1	61a	1 mm x-veneér	771L	LAS	Dør	Door	Tür	Porte	Deur
1	61b	1 mm x-veneér	771L	LAS	Håndtere	Handle	Handhaben	Gérer	Hendel
1	62	2 mm x-veneér	773L	LAS	Væg	Wall	Wand	Mur	Muur
4	63	2 mm x-veneér	773L	LAS	Væg	Wall	Wand	Mur	Muur
1	64	2 mm x-veneér	774L	LAS	Dæk	Deck	Deck	Pont	Dek
2	64a	1 mm x-veneér	771L	LAS	Koøje	Porthole	Bullauge	Hublot	Patrijspoot
2	65	1 mm x-veneér	772L	LAS	Beklædning	Sheathing	Ummantelung	Revêtement	Omhuysel

~24~

Antal	Nummer	Dimensions	Material	Found in	DK	GB	D	F	NL
2	66	1 mm x-veneér	771L	LAS	Beklædning	Sheathing	Ummantelung	Revêtement	Omhulsel
1	66a	1 mm x-veneér	770L	LAS	Koøje	Porthole	Bullauge	Hublot	Patrijspoort
2	67	1 mm x-veneér	770L	LAS	Beklædning	Sheathing	Ummantelung	Revêtement	Omhulsel
2	68	1 mm x-veneér	770L	LAS	Beklædning	Sheathing	Ummantelung	Revêtement	Omhulsel
1	68a	1 mm x-veneér	770L	LAS	Koøje	Porthole	Bullauge	Hublot	Patrijspoort
2	69	1 mm x-veneér	772L	LAS	Beklædning	Sheathing	Ummantelung	Revêtement	Omhulsel
2	70	1 mm x-veneér	770L	LAS	Beklædning	Sheathing	Ummantelung	Revêtement	Omhulsel
2	71	1 mm x-veneér	770L	LAS	Beklædning	Sheathing	Ummantelung	Revêtement	Omhulsel
1	71a	1 mm x-veneér	770L	LAS	Koøje	Porthole	Bullauge	Hublot	Patrijspoort
2	72	1 mm x-veneér	771L	LAS	Beklædning	Sheathing	Ummantelung	Revêtement	Omhulsel
12	72a	1 mm x-veneér	770L	LAS	Koøje	Porthole	Bullauge	Hublot	Patrijspoort
2	73	1 mm x-veneér	770L	LAS	Beklædning	Sheathing	Ummantelung	Revêtement	Omhulsel
60	74	1,8x7x880mm	Obechi	LB	Liste	Strip	Leisten	Baguettes	Strip
2	75	100x70x60mm	Balsa	TS	Agterstykke	Aft piece	Achtereil	Piece arriere	Achterschot
2	76	2 mm x-veneér	774L	LAS	Beslag	Support	Halterung	Support	Haakje
2	76a	2 mm x-veneér	774L	LAS	Beslag	Support	Halterung	Support	Haakje
2	76b	2 mm x-veneér	774L	LAS	Beslag	Support	Halterung	Support	Haakje
4	76c	2 mm x-veneér	774L	LAS	Beslag	Support	Halterung	Support	Haakje
4	76d	2 mm x-veneér	774L	LAS	Beslag	Support	Halterung	Support	Haakje
4	76e	2 mm x-veneér	774L	LAS	Beslag	Support	Halterung	Support	Haakje
4	76f	2 mm x-veneér	774L	LAS	Beslag	Support	Halterung	Support	Haakje
4	76g	2 mm x-veneér	774L	LAS	Beslag	Support	Halterung	Support	Haakje
4	76h	2 mm x-veneér	774L	LAS	Beslag	Support	Halterung	Support	Haakje
4	76i	2 mm x-veneér	774L	LAS	Beslag	Support	Halterung	Support	Haakje
4	76j	2 mm x-veneér	774L	LAS	Beslag	Support	Halterung	Support	Haakje
4	76k	2 mm x-veneér	774L	LAS	Beslag	Support	Halterung	Support	Haakje
2	77	1 mm x-veneér	771L	LAS	Gelænder	Railing	Geländer	Balustrade	Leuning
12	77a	1 mm x-veneér	771L	LAS	Gelænder	Railing	Geländer	Balustrade	Leuning
1	78	1 mm x-veneér	770L	LAS	Gelænder	Railing	Geländer	Balustrade	Leuning
1	79	1 mm x-veneér	770L	LAS	Gelænder	Railing	Geländer	Balustrade	Leuning
1	80	1 mm x-veneér	770L	LAS	Gelænder	Railing	Geländer	Balustrade	Leuning
1	81	1 mm x-veneér	770L	LAS	Gelænder	Railing	Geländer	Balustrade	Leuning
1	82	1 mm x-veneér	770L	LAS	Gelænder	Railing	Geländer	Balustrade	Leuning
2	83	1 mm x-veneér	771L	LAS	Gelænder	Railing	Geländer	Balustrade	Leuning
2	84	1 mm x-veneér	771L	LAS	Gelænder	Railing	Geländer	Balustrade	Leuning
2	85	1 mm x-veneér	770L	LAS	Beslag	Support	Halterung	Support	Haakje
1	86	2 mm x-veneér	773L	LAS	Kabine	Cabin	Kabine	Cabine	Cabine
2	87	2 mm x-veneér	773L	LAS	Kabine	Cabin	Kabine	Cabine	Cabine
1	88	2 mm x-veneér	773L	LAS	Kabine	Cabin	Kabine	Cabine	Cabine

Antal	Nummer	Dimensions	Material	Found in	DK	GB	D	F	NL
1	89	2 mm x-veneér	773L	LAS	Kabine	Cabin	Kabine	Cabine	Cabine
1	90	2 mm x-veneér	773L	LAS	Kabine	Cabin	Kabine	Cabine	Cabine
1	91	2 mm x-veneér	773L	LAS	Kabine	Cabin	Kabine	Cabine	Cabine
1	92	2 mm x-veneér	773L	LAS	Kabine	Cabin	Kabine	Cabine	Cabine
1	93	2 mm x-veneér	773L	LAS	Kabine	Cabin	Kabine	Cabine	Cabine
3	94	2 mm x-veneér	773L	LAS	Dør	Door	Tür	Porte	Deur
3	94a	1 mm x-veneér	771L	LAS	Håndtere	Handle	Handhaben	Gérer	Hendel
1	95	2 mm x-veneér	774L	LAS	Kabine	Cabin	Kabine	Cabine	Cabine
1	96	2 mm x-veneér	774L	LAS	Kabine	Cabin	Kabine	Cabine	Cabine
1	97	2 mm x-veneér	774L	LAS	Kabine	Cabin	Kabine	Cabine	Cabine
1	98	2 mm x-veneér	774L	LAS	Kabine	Cabin	Kabine	Cabine	Cabine
1	99	2 mm x-veneér	773L	LAS	Kabine	Cabin	Kabine	Cabine	Cabine
2	100	2 mm x-veneér	774L	LAS	Kabine	Cabin	Kabine	Cabine	Cabine
2	101	2 mm x-veneér	773L	LAS	Dør	Door	Tür	Porte	Deur
2	101a	1 mm x-veneér	771L	LAS	Håndtere	Handle	Handhaben	Gérer	Hendel
1	102	1 mm x-veneér	770L	LAS	Kabine	Cabin	Kabine	Cabine	Cabine
1	103	2 mm x-veneér	774L	LAS	Kabine	Cabin	Kabine	Cabine	Cabine
2	104	1 mm x-veneér	771L	LAS	Gelænder	Railing	Geländer	Balustrade	Leuning
4	104a	1 mm x-veneér	771L	LAS	Gelænder beslag	Railing support	Geländer halterung	Balustrade support	Leuning haakje
2	105	1 mm x-veneér	771L	LAS	Liste	Strip	Leisten	Baguettes	Strip
2	106	1 mm x-veneér	770L	LAS	Lampe, base	Lamp base	Lampen, Basis	Lampe, base	Lamp, basis
2	106a	1 mm x-veneér	770L	LAS	Lampe, base	Lamp base	Lampen, Basis	Lampe, base	Lamp, basis
2	106b	1 mm x-veneér	770L	LAS	Lampe, base	Lamp base	Lampen, Basis	Lampe, base	Lamp, basis
2	107	6 mm	Balsa	TS	Kabine	Cabin	Kabine	Cabine	Cabine
1	108	6 mm	Balsa	TS	Kabine	Cabin	Kabine	Cabine	Cabine
1	109	1 mm x-veneér	770L	LAS	Solafdækning	Sun cover	Sonnenschutz	Taud de soleil	Zonnescherm
4	110	2 mm x-veneér	773L	LAS	Spil	Winch	Winde	Treuil	Winch
1	111	1 mm x-veneér	770L	LAS	Luge	Hatch	Luke	Éclore	Klep
1	111a	2 mm x-veneér	773L	LAS	Luge	Hatch	Luke	Éclore	Klep
1	112	2 mm x-veneér	773L	LAS	Pullert	Bollard	Poller	Bitte d'amarrage	Bolder
4	113	1 mm x-veneér	771L	LAS	Spil	Winch	Winde	Treuil	Winch
8	113a	1 mm x-veneér	771L	LAS	Spil	Winch	Winde	Treuil	Winch
8	114	1 mm x-veneér	771L	LAS	Spil	Winch	Winde	Treuil	Winch
2	115	2 mm x-veneér	773L	LAS	Skab	Cabinet	Kabinett	Armoire	Kastje
2	115a	1 mm x-veneér	770L	LAS	Skab	Cabinet	Kabinett	Armoire	Kastje
3	116	2 mm x-veneér	774L	LAS	Pullert	Bollard	Poller	Bitte d'amarrage	Bolder
2	117	2 mm x-veneér	773L	LAS	Radarbase	Raddar base	Fuss für Radar	Radar, base	Radar, base
1	118	2 mm x-veneér	773L	LAS	Ror	Rudder	Ruder	Gouvernail	Roer
1	118a	2 mm x-veneér	773L	LAS	Ror	Rudder	Ruder	Gouvernail	Roer

Antal	Nummer	Dimensions	Material	Found in	DK	GB	D	F	NL
2	118b	1 mm x-veneér	770L	LAS	Ror	Rudder	Ruder	Gouvernail	Roer
1	119	1 mm x-veneér	771L	LAS	Ror	Rudder	Ruder	Gouvernail	Roer
6	120	1,8x2x400	Obechi	LB	Liste	Strip	Leisten	Baguettes	Strip
1	121	50x100mm	Acetate	VEJ	Vinduer	Windows	Fenster	Fenêtres	Ruiten
1	122	80x80x30mm	Balsa	TS	Skorsten	Chimney	Schornstein	Cheminée	Schoorsteen
1	122a	ø4x8mm	Brass	BF-B	Skorstensrør	Chimney pipe	Kaminrohr	Tuyau de cheminée	Schoorsteen pijp
1	123	100x100mm	Cloth	VEJ	Flag	Flag	Flaggen	Drapeau	Vlag
1	124	ø7mm	Brass	MS	Hovedmast	Main mast	Hauptmast	Mât, principal	Hoffmast
1	124a	1 mm x-veneér	771L	LAS	Maste fod	Maste step	Maststütze	Support de mât	Mastvoet
1	125	ø5mm	Brass	MS	Hovedbom	Main boom	Hauptbaum	Bôme, principal	Giek, hoff
1	126	ø7mm	Brass	MS	Fokkemast	Foremast	Fockmast	Mât de misaine	Fokmast
1	126a	1 mm x-veneér	771L	LAS	Maste fod	Maste step	Maststütze	Support de mât	Mastvoet
1	127	ø5mm	Brass	MS	Fokkestagbom	Forebom	Stagfockbaum	Etai de misaine	Fokboom
1	128	5 mm x-veneér	776L	LAS	Bedding	Bedding Slip	Helling	Cale de construction	Stander
1	129	5 mm x-veneér	776L	LAS	Bedding	Bedding Slip	Helling	Cale de construction	Stander
2	130	5 mm x-veneér	776L	LAS	Bedding	Bedding Slip	Helling	Cale de construction	Stander
3	131	5 mm x-veneér	776L	LAS	Bedding	Bedding Slip	Helling	Cale de construction	Stander
1	132	TR 183		VEJ	Transfers	Transfers	Abziehbilder	Decalcomanies	Transfers
2	133	2 mm x-veneér	774L	LAS	Beslag	Support	Halterung	Support	Haakje
1				VEJ	Tegning	Plan	Zeichnungen	Plans	Tekening
1		A4		VEJ	Byggevejledning	Building instruction	Bauanleitung	Instruction de montage	Bouwbeschrijving
2	F17	20mm	Brass	BF-C	Bombeslag	Boom fitting	Barfitting	Garniture du bôme	Lummel
9	F21	ø2x21mm	Brass	BF-C	Vantskrue	Rigging screw	Wantenschraube	Vis de ridage	Wantspanner
53	F30	20mm	Brass	BF-B	Gelænder	Railing	Geländer	Balustrade	Leuning
2	F37	15mm	Plastic	BF-A	Anker	Anchor	Anker	Ancre	Anker
8	F39	ø1,0x250mm	Brass	MS	Messingtrad	Brasswire	Messingdraht	Fils de laiton	Messingdraad
1	F52	ø9mm	Plastic	BF-A	Kompas	Compass	Kompass	Boussole	Kompas
1	F60	20mm	Plastic	BF-A	Ventil	Vent	Lüfter	Manche á air	Luchtoker
4	F64-1	5mm	Plastic	BF-A	Blok, Enkelt	Block, single	Block, einzel	Poulie, simple	Blok, enkel
13	F65	ø10mm	Brass	BF-D	Køøje	Portlight	Bullauge	Hublot	Patrijspoort
1	F70	10 m		TS	Rigningstråd	Rigging thread	Takelgarn	Fil de gréement	Takelgaren
1	F71	10 m		TS	Rigningstråd	Rigging thread	Takelgarn	Fil de gréement	Takelgaren
8	F115	14mm	Brass	BF-C	Pullert plade	Bollard plate	Pollerplatten	Planchette de bitte d'amarrage	Bolder platte
4	F121	ø6x7,5mm	Brass	BF-D	Lanterne	Lantern	Lanterne	Lanterne	Boordlichten
16	F135	ø6x10mm	Brass	BF-C	Pullert	Bollard	Poller	Bitte d'amarrage	Bolder
1	F141	10x20mm	Brass	BF-A, BF-C	Spotlight	Spotlight	Scheinwerfer	Projecteur	Schijnwerper
1	F146	20x30mm	Brass	BF-A, BF-D	Spil	Winch	Winde	Treuil	Winch
2	F147	12x32mm	Brass	BF-B	Spil	Winch	Winde	Treuil	Winch
2	F148	ø8mm	Brass	BF-D	Spil	Winch	Winde	Treuil	Winch

Antal	Nummer	Dimensions	Material	Found in	DK	GB	D	F	NL
1	F149	26mm	Brass	BF-C	Radar	Radar	Radar	Radar	Radar
1	F150	19mm	Brass	BF-C	Pejle radar	Bearing radar	Lagerradar	Radar portant	Lagerradar
2	F151	ø13x45mm	Brass	BF-C	Ventil	Vent	Lüfter	Manche á air	Luchtkoker
3	F152	ø10x38mm	Brass	BF-D	Ventil	Vent	Lüfter	Manche á air	Luchtkoker
6	F153	16mm	Brass	BF-B	Wirerulle	Wire reel	Wirerolle	Poulies	Katrollen
2	F155	ø3x33/56mm	Brass	BF-C	Bomholder	Boom support	Baumhalter	Support de bôme	Boompoot
2	F156	45x65mm	Brass	MS, BF-C	David	Davit	Davit	Bossoir	Davit
1	F158	ø8mm	Brass	BF-C	Kapstan	Capstan	Kapstan	Cabestan	Kaapstander
5	F181	13x60mm	Plastic	BF-A	Lejder	Ladder	Leiter	Echelle	Ladder
1	F233	90mm	Plastic	BF	Redningsbåd	Lifeboat	Rettungsboot	Canot de sauvetage	Reddingsboot
2	F379	ø5x1,5mm	Brass	BF-B	Mastknop	Mastknop	Masttop	Pommes de mát	Mastkloot
1	F581	ø6x135mm	Brass	MS, BF-C	Propel Aksel	Propeller shaft	Achse	Arbre port hélice	Schoefas
1	F582	4x83mm	Brass	MS, BF-D	Ror skaft	Rudder shaft	Ruderwelle	Arbre du gouvernail	Roeras
1	F947	ø35mm	Brass	BF	Skibsskrue	Propeller	Schiffsschraube	Hélice	Propeller

Antal	Nummer	Dimensions	Material	Found in	E	I	P	PL
1	1	5 mm x-veneér	775L	LAS	Unidad de quilla	Pezzo chiglia	Peca de quilha	Kil
1	2	5 mm x-veneér	775L	LAS	Cuaderna	Ordinata	Armacao	Wręga
1	3	5 mm x-veneér	775L	LAS	Cuaderna	Ordinata	Armacao	Wręga
1	4	5 mm x-veneér	775L	LAS	Cuaderna	Ordinata	Armacao	Wręga
1	5	5 mm x-veneér	776L	LAS	Cuaderna	Ordinata	Armacao	Wręga
1	6	5 mm x-veneér	775L	LAS	Cuaderna	Ordinata	Armacao	Wręga
1	7	5 mm x-veneér	775L	LAS	Cuaderna	Ordinata	Armacao	Wręga
1	8	5 mm x-veneér	775L	LAS	Cuaderna	Ordinata	Armacao	Wręga
3	9	5 mm x-veneér	775L	LAS	Cuaderna	Ordinata	Armacao	Wręga
1	10	5 mm x-veneér	776L	LAS	Cuaderna	Ordinata	Armacao	Wręga
1	11	5 mm x-veneér	776L	LAS	Cuaderna	Ordinata	Armacao	Wręga
1	12	5 mm x-veneér	775L	LAS	Cuaderna	Ordinata	Armacao	Wręga
1	13	5 mm x-veneér	775L	LAS	Cuaderna	Ordinata	Armacao	Wręga
1	14	5 mm x-veneér	776L	LAS	Cuaderna	Ordinata	Armacao	Wręga
1	15	5 mm x-veneér	776L	LAS	Cuaderna	Ordinata	Armacao	Wręga
1	16	5 mm x-veneér	776L	LAS	Soporte	Staffa	Suporte	Wspornik
1	17	5 mm x-veneér	776L	LAS	Soporte	Staffa	Suporte	Wspornik
1	18	5 mm x-veneér	776L	LAS	Soporte	Staffa	Suporte	Wspornik
1	19	5 mm x-veneér	776L	LAS	Soporte	Staffa	Suporte	Wspornik
1	20	2 mm x-veneér	773L	LAS	Soporte	Staffa	Suporte	Wspornik
1	21	1 mm x-veneér	771L	LAS	Cubierta	Ponte	Deck	Pokład
1	22	2 mm x-veneér	773L	LAS	Soporte	Staffa	Suporte	Wspornik
1	23	5 mm x-veneér	775L	LAS	Cuaderna	Ordinata	Armacao	Wręga

Antal	Nummer	Dimensions	Material	Found in	E	I	P	PL
1	24	5 mm x-veneér	775L	LAS	Cuaderna	Ordinata	Armacao	Wręga
1	25	1 mm x-veneér	771L	LAS	Cuaderna	Ordinata	Armacao	Wręga
1	25	2 mm x-veneér	773L	LAS	Cuaderna	Ordinata	Armacao	Wręga
1	26	1 mm x-veneér	771L	LAS	Cuaderna	Ordinata	Armacao	Wręga
1	26	2 mm x-veneér	773L	LAS	Cuaderna	Ordinata	Armacao	Wręga
2	27	1 mm x-veneér	771L	LAS	Cuaderna	Ordinata	Armacao	Wręga
1	28	1 mm x-veneér	771L	LAS	Cuaderna	Ordinata	Armacao	Wręga
2	29	5 mm x-veneér	775L	LAS	Cuaderna	Ordinata	Armacao	Wręga
2	30	2 mm x-veneér	773L	LAS	Soporte	Staffa	Suporte	Wspornik
1	31	2 mm x-veneér	773L	LAS	Soporte	Staffa	Suporte	Wspornik
1	32	5 mm x-veneér	775L	LAS	Soporte	Staffa	Suporte	Wspornik
1	33	5 mm x-veneér	775L	LAS	Soporte	Staffa	Suporte	Wspornik
4	34	5 mm x-veneér	776L	LAS	Soporte	Staffa	Suporte	Wspornik
1	35	5 mm x-veneér	775L	LAS	Soporte	Staffa	Suporte	Wspornik
2	36	5 mm x-veneér	775L	LAS	Soporte	Staffa	Suporte	Wspornik
1	37	5 mm x-veneér	776L	LAS	Soporte	Staffa	Suporte	Wspornik
1	38	5 mm x-veneér	775L	LAS	Soporte	Staffa	Suporte	Wspornik
1	39	1 mm x-veneér	770L	LAS	Cubierta	Ponte	Deck	Pokład
1	40	1 mm x-veneér	770L	LAS	Cubierta	Ponte	Deck	Pokład
1	41	5 mm x-veneér	775L	LAS	Soporte	Staffa	Suporte	Wspornik
1	42	5 mm x-veneér	775L	LAS	Soporte	Staffa	Suporte	Wspornik
1	43	5 mm x-veneér	775L	LAS	Soporte	Staffa	Suporte	Wspornik
1	44	5 mm x-veneér	776L	LAS	Soporte	Staffa	Suporte	Wspornik
1	45	5 mm x-veneér	775L	LAS	Soporte	Staffa	Suporte	Wspornik
1	46	1 mm x-veneér	771L	LAS	Escaleras	Scale	Escadaria	Schody
1	46a	1 mm x-veneér	771L	LAS	Escaleras	Scale	Escadaria	Schody
1	47	1 mm x-veneér	771L	LAS	Escaleras	Scale	Escadaria	Schody
1	47a	1 mm x-veneér	771L	LAS	Escaleras	Scale	Escadaria	Schody
14	48	1 mm x-veneér	771L	LAS	Escaleras	Scale	Escadaria	Schody
16	48a – 48h	1 mm x-veneér	771L	LAS	Escaleras	Scale	Escadaria	Schody
1	49	2 mm x-veneér	773L	LAS	Cubierta	Ponte	Deck	Pokład
1	50	2 mm x-veneér	773L	LAS	Cubierta	Ponte	Deck	Pokład
2	51	2 mm x-veneér	773L	LAS	Escotilla	Schiudere	Escotilha	Właz
2	52	2 mm x-veneér	773L	LAS	Escotilla	Schiudere	Escotilha	Właz
1	53	1 mm x-veneér	771L	LAS	Escotilla	Schiudere	Escotilha	Właz
1	53a	2 mm x-veneér	774L	LAS	Escotilla	Schiudere	Escotilha	Właz
1	53b	2 mm x-veneér	774L	LAS	Escotilla	Schiudere	Escotilha	Właz
1	54	2 mm x-veneér	773L	LAS	Escotilla	Schiudere	Escotilha	Właz
1	55	2 mm x-veneér	773L	LAS	Escotilla	Schiudere	Escotilha	Właz

Antal	Nummer	Dimensions	Material	Found in	E	I	P	PL
2	56	2 mm x-veneér	773L	LAS	Escotilla	Schiudere	Escotilha	Właz
2	57	2 mm x-veneér	773L	LAS	Escotilla	Schiudere	Escotilha	Właz
1	58	1 mm x-veneér	771L	LAS	Escotilla	Schiudere	Escotilha	Właz
1	59	2 mm x-veneér	773L	LAS	Escotilla	Schiudere	Escotilha	Właz
1	59a	2 mm x-veneér	774L	LAS	Escotilla	Schiudere	Escotilha	Właz
1	59b	2 mm x-veneér	774L	LAS	Escotilla	Schiudere	Escotilha	Właz
1	60	2 mm x-veneér	773L	LAS	Escotilla	Schiudere	Escotilha	Właz
1	61	2 mm x-veneér	773L	LAS	Muro	Parete	Parede	Ściana
1	61a	1 mm x-veneér	771L	LAS	Puerta	Porta	Porta	Drzwi
1	61b	1 mm x-veneér	771L	LAS	Manejar	Maniglia	Lidar	Klamka
1	62	2 mm x-veneér	773L	LAS	Muro	Parete	Parede	Ściana
4	63	2 mm x-veneér	773L	LAS	Muro	Parete	Parede	Ściana
1	64	2 mm x-veneér	774L	LAS	Cubierta	Ponte	Deck	Pokład
2	64a	1 mm x-veneér	771L	LAS	Porta	Oblò	Escotilha	Bulaj
2	65	1 mm x-veneér	772L	LAS	Revestimiento	Guaina	Revestimento	Poszycie
2	66	1 mm x-veneér	771L	LAS	Revestimiento	Guaina	Revestimento	Poszycie
1	66a	1 mm x-veneér	770L	LAS	Porta	Oblò	Escotilha	Bulaj
2	67	1 mm x-veneér	770L	LAS	Revestimiento	Guaina	Revestimento	Poszycie
2	68	1 mm x-veneér	770L	LAS	Revestimiento	Guaina	Revestimento	Poszycie
1	68a	1 mm x-veneér	770L	LAS	Porta	Oblò	Escotilha	Bulaj
2	69	1 mm x-veneér	772L	LAS	Revestimiento	Guaina	Revestimento	Poszycie
2	70	1 mm x-veneér	770L	LAS	Revestimiento	Guaina	Revestimento	Poszycie
2	71	1 mm x-veneér	770L	LAS	Revestimiento	Guaina	Revestimento	Poszycie
1	71a	1 mm x-veneér	770L	LAS	Porta	Oblò	Escotilha	Bulaj
2	72	1 mm x-veneér	771L	LAS	Revestimiento	Guaina	Revestimento	Poszycie
12	72a	1 mm x-veneér	770L	LAS	Porta	Oblò	Escotilha	Bulaj
2	73	1 mm x-veneér	770L	LAS	Revestimiento	Guaina	Revestimento	Poszycie
60	74	1,8x7x880mm	Obechi	LB	Liston	Listello	Tira	Listwa
2	75	100x70x60mm	Balsa	TS	Pieza de popa	Dritto di poppa	Peca de popa	Balsa
2	76	2 mm x-veneér	774L	LAS	Soporte	Staffa	Suporte	Wspornik
2	76a	2 mm x-veneér	774L	LAS	Soporte	Staffa	Suporte	Wspornik
2	76b	2 mm x-veneér	774L	LAS	Soporte	Staffa	Suporte	Wspornik
4	76c	2 mm x-veneér	774L	LAS	Soporte	Staffa	Suporte	Wspornik
4	76d	2 mm x-veneér	774L	LAS	Soporte	Staffa	Suporte	Wspornik
4	76e	2 mm x-veneér	774L	LAS	Soporte	Staffa	Suporte	Wspornik
4	76f	2 mm x-veneér	774L	LAS	Soporte	Staffa	Suporte	Wspornik
4	76g	2 mm x-veneér	774L	LAS	Soporte	Staffa	Suporte	Wspornik
4	76h	2 mm x-veneér	774L	LAS	Soporte	Staffa	Suporte	Wspornik
4	76i	2 mm x-veneér	774L	LAS	Soporte	Staffa	Suporte	Wspornik

Antal	Nummer	Dimensions	Material	Found in	E	I	P	PL
4	76j	2 mm x-veneér	774L	LAS	Soporte	Staffa	Suporte	Wspornik
4	76k	2 mm x-veneér	774L	LAS	Soporte	Staffa	Suporte	Wspornik
2	77	1 mm x-veneér	771L	LAS	Pretil	Corrimano	Corrimão	Poręcz
12	77a	1 mm x-veneér	771L	LAS	Pretil	Corrimano	Corrimão	Poręcz
1	78	1 mm x-veneér	770L	LAS	Pretil	Corrimano	Corrimão	Poręcz
1	79	1 mm x-veneér	770L	LAS	Pretil	Corrimano	Corrimão	Poręcz
1	80	1 mm x-veneér	770L	LAS	Pretil	Corrimano	Corrimão	Poręcz
1	81	1 mm x-veneér	770L	LAS	Pretil	Corrimano	Corrimão	Poręcz
1	82	1 mm x-veneér	770L	LAS	Pretil	Corrimano	Corrimão	Poręcz
2	83	1 mm x-veneér	771L	LAS	Pretil	Corrimano	Corrimão	Poręcz
2	84	1 mm x-veneér	771L	LAS	Pretil	Corrimano	Corrimão	Poręcz
2	85	1 mm x-veneér	770L	LAS	Soporte	Staffa	Suporte	Wspornik
1	86	2 mm x-veneér	773L	LAS	Cabina	Cabina	Cabine	Kabina
2	87	2 mm x-veneér	773L	LAS	Cabina	Cabina	Cabine	Kabina
1	88	2 mm x-veneér	773L	LAS	Cabina	Cabina	Cabine	Kabina
1	89	2 mm x-veneér	773L	LAS	Cabina	Cabina	Cabine	Kabina
1	90	2 mm x-veneér	773L	LAS	Cabina	Cabina	Cabine	Kabina
1	91	2 mm x-veneér	773L	LAS	Cabina	Cabina	Cabine	Kabina
1	92	2 mm x-veneér	773L	LAS	Cabina	Cabina	Cabine	Kabina
1	93	2 mm x-veneér	773L	LAS	Cabina	Cabina	Cabine	Kabina
3	94	2 mm x-veneér	773L	LAS	Puerta	Porta	Porta	Drzwi
3	94a	1 mm x-veneér	771L	LAS	Manejar	Maniglia	Lidar	Klamka
1	95	2 mm x-veneér	774L	LAS	Cabina	Cabina	Cabine	Kabina
1	96	2 mm x-veneér	774L	LAS	Cabina	Cabina	Cabine	Kabina
1	97	2 mm x-veneér	774L	LAS	Cabina	Cabina	Cabine	Kabina
1	98	2 mm x-veneér	774L	LAS	Cabina	Cabina	Cabine	Kabina
1	99	2 mm x-veneér	773L	LAS	Cabina	Cabina	Cabine	Kabina
2	100	2 mm x-veneér	774L	LAS	Cabina	Cabina	Cabine	Kabina
2	101	2 mm x-veneér	773L	LAS	Puerta	Porta	Porta	Drzwi
2	101a	1 mm x-veneér	771L	LAS	Manejar	Maniglia	Lidar	Klamka
1	102	1 mm x-veneér	770L	LAS	Cabina	Cabina	Cabine	Kabina
1	103	2 mm x-veneér	774L	LAS	Cabina	Cabina	Cabine	Kabina
2	104	1 mm x-veneér	771L	LAS	Pretil	Corrimano	Corrimão	Poręcz
4	104a	1 mm x-veneér	771L	LAS	Pretil soporte	Corrimano staffa	Corrimão suporte	Wspornik poręczy
2	105	1 mm x-veneér	771L	LAS	Liston	Listello	Tira	Listwa
2	106	1 mm x-veneér	770L	LAS	Lámpara, base	Lampade, base	Lâmpada, base	Podstawa lampy
2	106a	1 mm x-veneér	770L	LAS	Lámpara, base	Lampade, base	Lâmpada, base	Podstawa lampy
2	106b	1 mm x-veneér	770L	LAS	Lámpara, base	Lampade, base	Lâmpada, base	Podstawa lampy
2	107	6 mm	Balsa	TS	Cabina	Cabina	Cabine	Kabina

Antal	Nummer	Dimensions	Material	Found in	E	I	P	PL
1	108	6 mm	Balsa	TS	Cabina	Cabina	Cabine	Kabina
1	109	1 mm x-veneér	770L	LAS	Cubierta solar	Copertura solare	Protetor solar	Oślona
4	110	2 mm x-veneér	773L	LAS	Chigre	Verricello	Guincho	Wciągarka
1	111	1 mm x-veneér	770L	LAS	Escotilla	Schiudere	Escotilha	Właz
1	111a	2 mm x-veneér	773L	LAS	Escotilla	Schiudere	Escotilha	Właz
1	112	2 mm x-veneér	773L	LAS	Bitones	Bitta	Poste de amarracao	Pacholek
4	113	1 mm x-veneér	771L	LAS	Chigre	Verricello	Guincho	Wciągarka
8	113a	1 mm x-veneér	771L	LAS	Chigre	Verricello	Guincho	Wciągarka
8	114	1 mm x-veneér	771L	LAS	Chigre	Verricello	Guincho	Wciągarka
2	115	2 mm x-veneér	773L	LAS	Gabinete	Mobiletto	Gabinete	Szafka
2	115a	1 mm x-veneér	770L	LAS	Gabinete	Mobiletto	Gabinete	Szafka
3	116	2 mm x-veneér	774L	LAS	Bitones	Bitta	Poste de amarracao	Pacholek
2	117	2 mm x-veneér	773L	LAS	Radar, base	Radar, base	Radar, base	Podstawa radaru
1	118	2 mm x-veneér	773L	LAS	Timón	Timone	Leme	Ster
1	118a	2 mm x-veneér	773L	LAS	Timón	Timone	Leme	Ster
2	118b	1 mm x-veneér	770L	LAS	Timón	Timone	Leme	Ster
1	119	1 mm x-veneér	771L	LAS	Timón	Timone	Leme	Ster
6	120	1,8x2x400	Obechi	LB	Liston	Listello	Tira	Listwa
1	121	50x100mm	Acetate	VEJ	Ventanas	Finestrini	Janelas	Okna
1	122	80x80x30mm	Balsa	TS	Chimenea	Ciminiera	Chaminé	Komin
1	122a	ø4x8mm	Brass	BF-B	Tube de chimenea	Canna fumaria	Chaminé	Rura kominowa
1	123	100x100mm	Cloth	VEJ	Bandera	Bandiera	Bandeira	Flaga
1	124	ø7mm	Brass	MS	Palo, principal	Albero, principale	Mastro, principal	Maszt główny
1	124a	1 mm x-veneér	771L	LAS	Pie de mástil	Piede d'albero	Pé de mastro	Wpornik masztu
1	125	ø5mm	Brass	MS	Botavara, principal	Boma, principale	Retranca, principal	Bom główny
1	126	ø7mm	Brass	MS	Fokmast	Albero di trinchetto	Mastro dianteiro	Fokmaszt
1	126a	1 mm x-veneér	771L	LAS	Pie de mástil	Piede d'albero	Pé de mastro	Wspornik masztu
1	127	ø5mm	Brass	MS	Fokboom	Straglio di trinchetto	Botaló do tirante dianteiro	Bom fokmasztu
1	128	5 mm x-veneér	776L	LAS	Soporte del casco	Supporto	Suporte para o casco	Podstawka
1	129	5 mm x-veneér	776L	LAS	Soporte del casco	Supporto	Suporte para o casco	Podstawka
2	130	5 mm x-veneér	776L	LAS	Soporte del casco	Supporto	Suporte para o casco	Podstawka
3	131	5 mm x-veneér	776L	LAS	Soporte del casco	Supporto	Suporte para o casco	Podstawka
1	132	TR 183		VEJ	Transfer	Decalcomanie	Decalques	Kalkomania
2	133	2 mm x-veneér	774L	LAS	Soporte	Staffa	Suporte	Wspornik
1				VEJ	Ilustracion	Piani di costruzione	Planta principal	Rysunek
1		A4		VEJ	Instrucciones de construction	Istruzioni dei montaggio	Instrucoes de montagem	Instrukcja budowy
2	F17	20mm	Brass	BF-C	Herrajes de botavara	Bar-montaggi	Bar-acessórios	Okucie bomu
9	F21	ø2x21mm	Brass	BF-C	Tensor de obenques	Vite sartie	Parafuso do cordame	Śruba olinowania
53	F30	20mm	Brass	BF-B	Pretil	Corrimano	Corrimão	Poręcz

Antal	Numer	Dimensions	Material	Found in	E	I	P	PL
2	F37	15mm	Plastic	BF-A	Ancla	Ancora	Ancora	Kotwica
8	F39	ø1,0x250mm	Brass	MS	Hilo de laton	Filo in ottone	Tubo do guincho	Drut
1	F52	ø9mm	Plastic	BF-A	Brújula	Bussola	Bússola	Kompas
1	F60	20mm	Plastic	BF-A	Respiradero	Valvola	Respiradouro	Wentylacja
4	F64-1	5mm	Plastic	BF-A	Polea, simple	Blocco, semplice	Bloco, simples	Blok pojedynczy
13	F65	ø10mm	Brass	BF-D	Portilla	Oblò	Luz de bombordo	Bulaj
1	F70	10 m		TS	Hilo de aparejo	Filo per manovre	Linha de cordame	Sznurek
1	F71	10 m		TS	Hilo de aparejo	Filo per manovre	Linha de cordame	Sznurek
8	F115	14mm	Brass	BF-C	Placa de bitón	Piastre bitta	Suporte do poste de amarração	Podstawa pacholka
4	F121	ø6x7,5mm	Brass	BF-D	Linterna	Lanterna	Lanternas	Latarnia
16	F135	ø6x10mm	Brass	BF-C	Bitones	Bitta	Poste de amarração	Pacholek
1	F141	10x20mm	Brass	BF-A, BF-C	Destacar	Riflettore	Holofote	Reflektor
1	F146	20x30mm	Brass	BF-A, BF-D	Chigre	Verricello	Guincho	Wciągarka
2	F147	12x32mm	Brass	BF-B	Chigre	Verricello	Guincho	Wciągarka
2	F148	ø8mm	Brass	BF-D	Chigre	Verricello	Guincho	Wciągarka
1	F149	26mm	Brass	BF-C	Radar	Radar	Radar	Radar
1	F150	19mm	Brass	BF-C	Radar de rodamiento	Radar cuscinetto	Radar de rolamento	Łożysko radaru
2	F151	ø13x45mm	Brass	BF-C	Respiradero	Valvola	Respiradouro	Wentylacja
3	F152	ø10x38mm	Brass	BF-D	Respiradero	Valvola	Respiradouro	Wentylacja
6	F153	16mm	Brass	BF-B	Rodillos alambre	Puleggia	Polias	Drut, szpula
2	F155	ø3x33/56mm	Brass	BF-C	Soporte de botavara	Supporto albero	Suporte da balisa	Wspornik bomu
2	F156	45x65mm	Brass	MS, BF-C	Pescante	Gruetta	Turco	Żuraw
1	F158	ø8mm	Brass	BF-C	Cabrestante	Argano	Cabrestante	Kabestan
5	F181	13x60mm	Plastic	BF-A	Escalera	Scaletta	Escada	Drabina
1	F233	90mm	Plastic	BF	Bote salvavidas	Battello di salvataggio	Barco salva-vidas	Szalupa
2	F379	ø5x1,5mm	Brass	BF-B	Sombrerete de palo	Estremità superiore dell'albero	Topo do mastro	Maszt
1	F581	ø6x135mm	Brass	MS, BF-C	Je de hélice	Supporti per corrimano	Pontalete da amurada	Wał napędowy
1	F582	4x83mm	Brass	MS, BF-D	Eje del timón	Albero di timone	Eixo do leme	Wał steru
1	F947	ø35mm	Brass	BF	Hélice	Elica	Hélice	Śruba

PACKING GROUPS

BF



A



B



774L-133

C



D



LAS

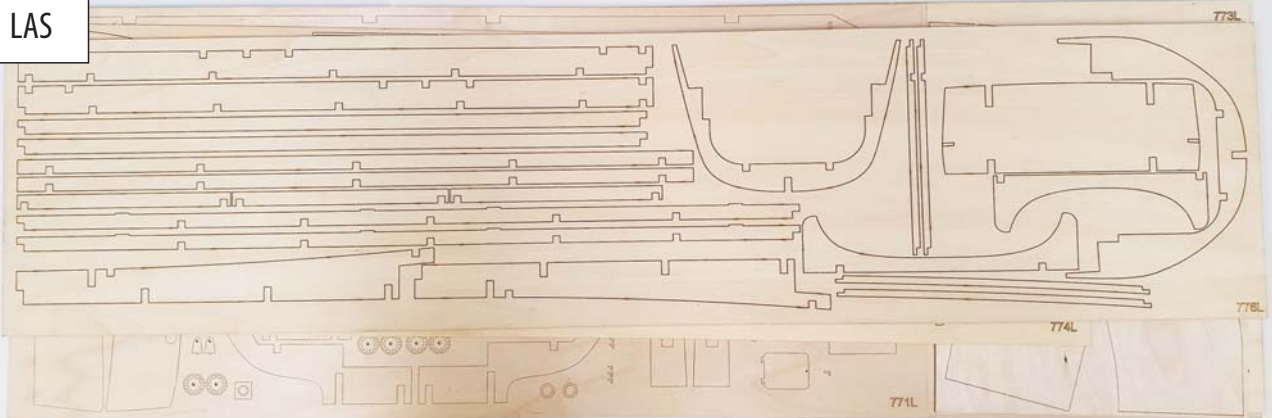

LB



TS



MS





Billing Boats

www.billingboats.com
service@billingboats.dk

POST PRODUCTION CORRECTIONS

Please read before assembly

I Ignore four holes on frame number 4

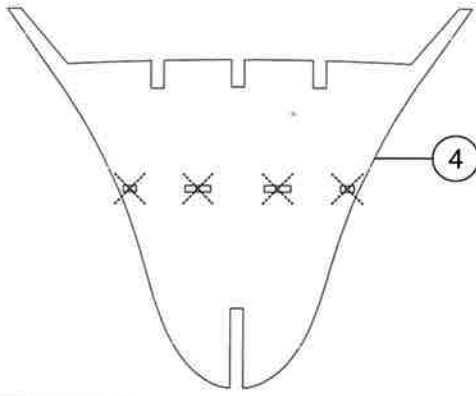

II Ignore two holes on frame number 15

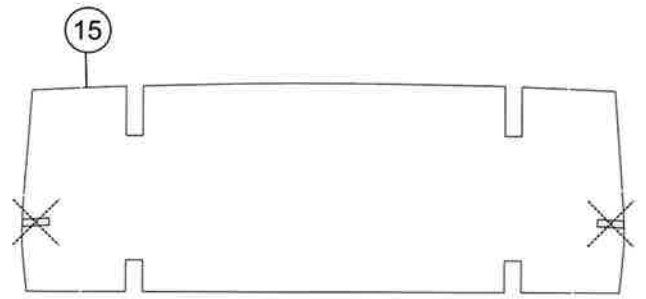

III Do not use parts number 37



IV Remove marked pins from the deck number 49
(cut along dotted line)

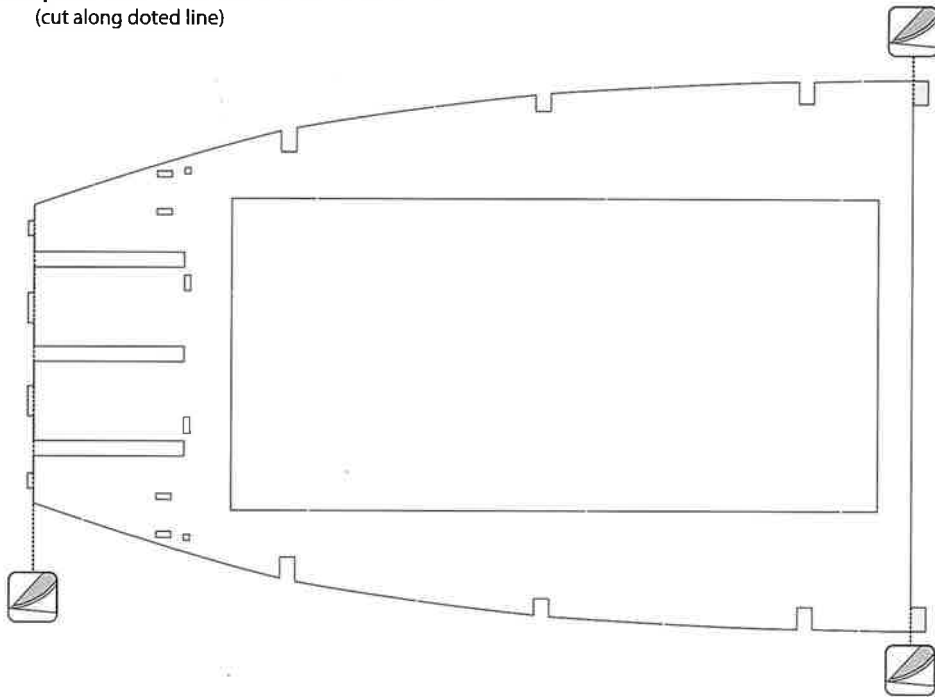

V Remove marked pegs from part 96

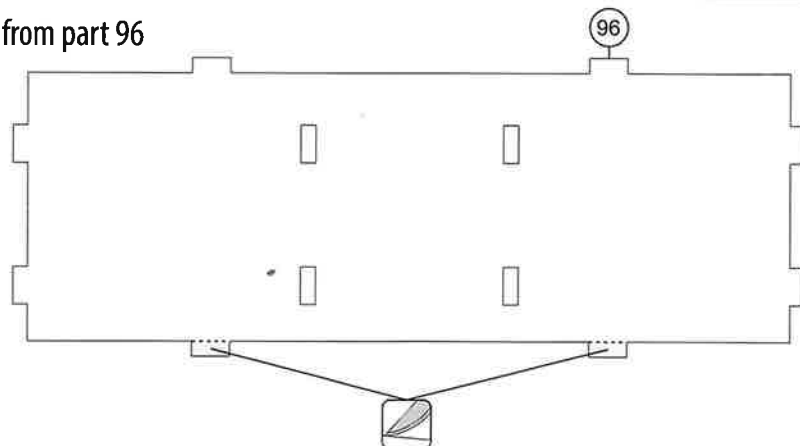

103 Template 1:1



VI Use only two parts number 117

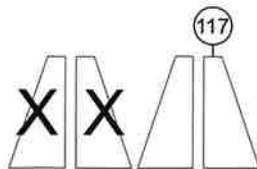

VII Part number change in manual on page 15

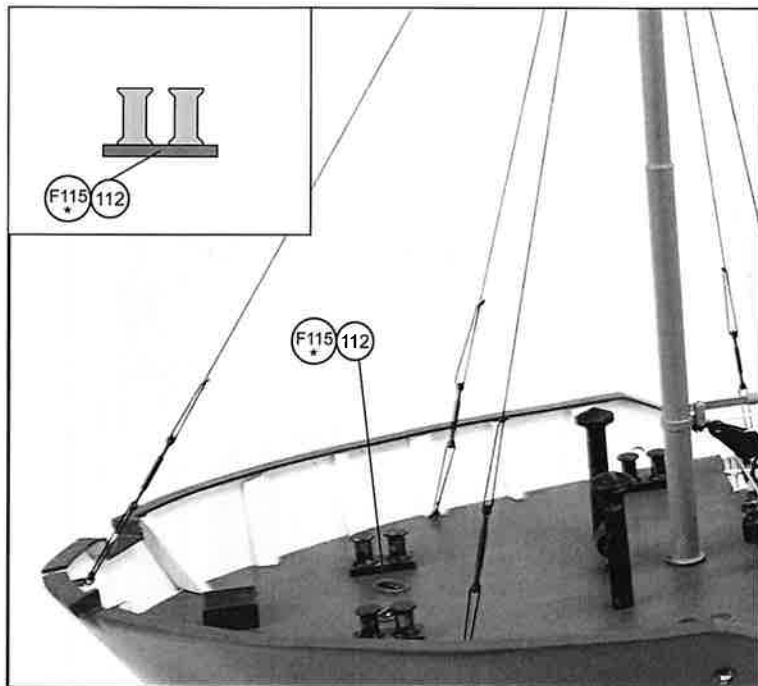

VIII Part number change in manual on page 16



IX To see our color conversion chart please visit <https://www.billingboats.com/faq>

Til denne model er mahogni bejdse og farver med følgende numre nødvendige:

For this model is mahogany stain and colours with the following numbers should be used:

Für dieses Modell sind Mahagoni Beize und Farben mit den folgenden Nummern notwendig:

Pour ce modèle, le mordant et les couleurs avec les numéros suivants doivent être employés:

Voor dit model zijn kleuren met de volgende nummers nodig:

Para este modelo se necesitan mordiente et colores con los siguientes números:

Per questo modello occorrono inchiostro tinteggiatore "mogano" e colori con questi numeri:

Pinte o modelo com tintura cor Mogno e as cores sugeridas da Billing Boats:

W przypadku tego modelu należy użyć bejcy mahoniową oraz farby o numerach:

Billing 1	= White
Billing 6	= Hull Red
Billing 11	= Black
Billing 12	= Pale Grey
Billing 16	= Gold
Billing 18	= Mediterranean Blue
Billing 20	= Satin Brown
Billing 30	= Dark Ad Grey
Billing 35	= Signal Red

Parts marked in grey should not be used.
Please use the replacement parts included.

