

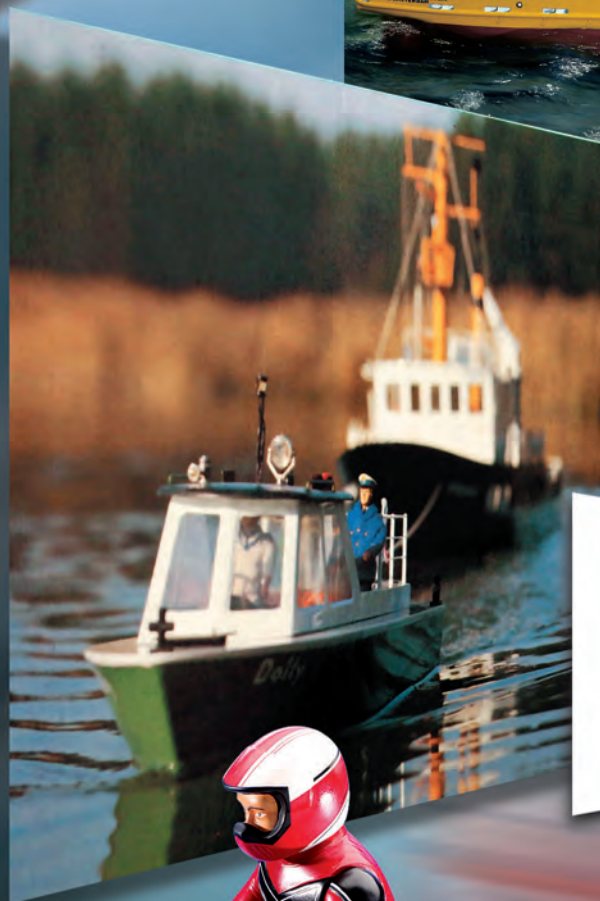

Catalog 2018

Model Boats & Accessories

Made in Germany



by **krick**

www.ro-marin.com

THE MODEL-INDEX

The system with the stars

In order to make the selection of model kits easy even for inexperienced modellers, we have a system in this catalog that represents the level of experience of the modeler or the model operator in general terms. Of course, this system can only be a rough guide and therefore cannot guarantee success.

Please also note that the stars only show the level of experience in the respective model discipline, which means, for example, that an expert in ship model making cannot start with an expert aircraft model.

Following the individual steps with explanation:



Simple kit, no experience required



Simple, no basic knowledge, but some skill and crafting experience recommended.



Not a first model. Minor experience in the respective model discipline is required.



General experience in the respective model discipline is required. The construction manual is not based on basic knowledge.



Only for experts. Well-founded knowledge in the respective model discipline is absolutely essential. The construction manual is not based on basic knowledge.

All articles in this catalog as well as accessories, spare parts and materials are available through the model trade and on the Internet at www.krickshop.de

For more information, please contact your retailer or www.krick-modell.de

krick

Klaus Krick Modelltechnik

Owner Matthias Krick

Industriestr. 1 · 75348 Knittlingen

Tel. +49 (0) 70 43 - 9 35 10

Fax +49 (0) 70 43 - 3 18 38

E-Mail: service@krick-modell.de

Internet: www.krick-modell.de

Reproduction of texts and illustrations, even in extracts, is only permitted with the express permission of the publisher. For printing errors no liability can be assumed. We can not pay for any liability or consequential damage during the operation of and with products from our delivery program, as proper operation or use can not be monitored.

As of January 2018.

Design: www.bildwerk.de



The new brand in the **krick** range

With the closure of Robbe-Modellsport, Germany, we decided not to let die the interesting and timeless ship model designs from Robbe, but continue to produce in our facility, to integrate into our ship model range and to adapt to modern manufacturing methods. We will continue to revive these ship model designs and the large range of accessories under the brand RO-marin in future.

RO-marin ship models are characterized by a high degree of prefabrication of the ABS hulls and other plastic parts. The fittings made of plastic and metal are legendary and thus represent an excellent addition to our previous rather classically oriented kit range.

In addition to the outstanding shapes of these ship models, we now have the opportunity to combine them with our very accurate laser cutting and laser engraving technology. It is our aim to produce the previous models even more faithfully and in finer detail, so that they meet the current demands of a ship model. On and on we go deeper into the design, changing and enhancing the detail of the RO-marin kits, without losing the charm of these designs.

Like the entire Krick model assortment, the RO-marin range is constantly being expanded and growing piece by piece. Therefore, this catalog can never be up to date and complete. For this reason, we are always expanding our websites. On www.krick-modell.de you can find almost daily new items. Use this option for even more accurate and up-to-date information. You will also find information about our catalogs on the rear page. We are happy if you also use these.



Have fun browsing
this catalog
Your
Matthias Krick



Company building in Knittlingen

SEA-JET EVOLUTION RAPID WATER SPORTS FOR BRUSHLESS E-DRIVE

After many successful years of the robbe Sea-Jet, the Sea-Jet Evolution has become established in the Sea-Jet Cup competitions worldwide with higher performance and modern look. Based on the modern race jets of the competition classes, the visual appearance is much sleeker than that of its predecessor. To improve its lateral stability, the hull wider, and lowered in height. The Evolution can be constructed as a dual brushless motor drive, This ensures high speed. But even with a cheaper brush motor variant it is really fun and of course can be easily updated later to a high performance brushless motor configuration. As the propellers are now direct drive (no gear box as the previous version) Changes can be made without adjusting the prop shaft. A centrally located rudder and optimized hull shape guarantee high maneuverability and driving pleasure.

RC-Model

Power unit	Electric Motor
Length about	685 mm
Width about	240 mm
Height about	370 mm
Total displacement about	2100 g

RC functions

rudder control, engine control

Order no. ★★★★★★
ro1266 kit Sea-Jet Evolution



Made in Germany

Kit Contents

- Hull, deck and seat made of vacuum formed, black ABS plastic
- Rubber profile as edge protection
- Laser cut parts for drive and RC installation
- Multipart driver figure made of plastic
- Handlebar and mirror made of molded plastic parts
- Shafts Ø 4 mm with stern tubes (2x)
- Propellers (left and right handed)
- Wedge rudder with bracket
- Small accessories for assembly
- Multi-coloured decal sheet
- Multilingual construction manual
- Boat stand

Optional drive sets

- ro1268 Brushless drive set with 2 ROXXY BL Inrunner motors 2845/07, couplings and cooling coils
- or
- ro1267 Standard brushed drive set with 2 brush motors, suppression kit, matching couplings and cooling coils



Optional accessories for Radio Control

- 67072 Speed control Seaking 60A (2 pieces) with brushless drive
- 67052 Cruise control Quicrun 860 Dual with brushed drive
- 79054 rudder servo
- Remote control from 2-channel

KATJA MOTORYACHT CONSTRUCTION KIT

Katja is the successful replica of an elegant, four-seat sport boat with inboard engine. The model essentially consists of seven plastic parts. Deck and cabin are made in one piece from transparent plastic. Thus eliminates the costly cutting and pasting of the windows. The Katja can be used as a free-running model or radio controlled. At free run, the rudder is set to a fixed radius. Equipped with a radio control, the Katja is extremely agile and due to the electric motor very nimble. We recommend the Katja as the ideal fun model for the beginner.

Kit Contents

- Hull, deck, cabin insert, seat back dashboard made of white colored or transparent plastic
- Complete stern tube with coupling and three-blade propeller
- Rudder with rudder lever and steering linkage
- Decals, masks for windows
- All fittings such as cleats, steering wheel, flag and horns
- Detailed construction manual and construction drawings

Optional accessories for operation with remote control

Order no.

- 42235 MAX Speed 400 electric motor
- 42128 Suppressor kit for electric motors
- 67051 Electronic speed controller
- 79050 Standard servo for rudder function
- 667240 drive battery 7.2 V 3000 mAh
- roF2201 2-channel remote control
- Motor connection cable and plug

Optional accessories for operation without remote control

Order no.

- 42235 MAX Speed 400 electric motor,
approx. 50 cm cable and as a
power source a 4.5V flashlight
battery



Length about **520 mm**
Width about **180 mm**
Total displacement about **1100 g**

Order no. ★★☆☆☆☆
ro1020 kit motor yacht Katja



**RC-
Model**



NAJADE MODEL OF A LUXURY-MOTORYACHT IN SCALE 1:15

The Najade is a spacious motor yacht, as found in many Mediterranean ports. Like its prototype, the Najade has a large and spacious cabin, a mighty flybridge and a shapely stern with a swim platform. The hull tolerates a powerful motor for fast ride. This is done, for example, by the BL motor ROXXY 3656-06, which directly drives the ship's propeller via the prop shaft. The drive is not included in the kit, so that the model builder is given the freedom for his own drive concept. In order to make the construction of this impressive model progress rapidly, e.g. the glazing formed of transparent material. Together with the included fittings kit and the large decal sheet, this results in a perfect finish for the Najade.



**RC-
Model**

Kit Contents

- Thermoformed plastic hull
 - Thermoformed plastic deck and body parts
 - Transparent, deep-drawn glazing
 - Laser cut plastic parts for RC installation
 - Stern tube with shaft and propeller
 - Accessories for engine and RC installation
 - Double steering gear
 - Complete fittings kit
 - Decal sheet
 - Multilingual, illustrated construction manual
 - Boat stand
- Paint and adhesives are not included



Optional accessories

Drive standard version

- 42260 Motor Max Speed 800
- 42123 Water cooling coil
- 67052 Speed Controller WP860 Dual

Optional accessories

Drive brushless version

- ro4786 BL motor ROXXY 3656-06
- 42122 Water cooling coil
- 67073 Speed Controller Seaking 120 A

Scale 1:15
Length 960 mm
Width 300 mm
Total displacement 3600 g

Order no. ★★★★★☆
ro1160 kit Najade with
Hardware kit without motor

Further information can be found at www.krick-modell.de

SAN DIEGO SEMI SCALE MODEL OF A MEGA-YACHT 1:25

NEW

With its sleek design, the San Diego delivers a fantastic ride that is in no way inferior to its original. The large hull length of 1.27 m and the slim design make for a great and faithful appearance on the water, which reflects the elegance of such luxury yachts. Equipped with two powerful electric motors (frame sizes 700 to 800) that drive two counter-rotating surface ship propellers directly, the San Diego starts to plane contact after a short acceleration phase. Pivoting Navy Speed drives on the one hand allow a very good directional stability, on the other hand a high maneuverability even with moving water. With the fitting kit, the luxurious features of the original boat can be completely replicated in the model.



delivery

- Hull and deck deep drawn from plastic, with moulded spray rails.
- 2 Navy Speed direct drives
- 2 Navy 44 universal joint couplings
- 2 stern tubes with shafts
- Rubbing strips, high coaming
- Superstructure can be removed in one piece, individual parts of the superstructure are made of transparent plastic
- Laser cut plastic parts for interior fitting and fly bridge
- RC parts, decals
- Detailed construction manual



Length about 1270 mm
Width about 250 mm
Height about 370 mm
Total displacement about 5000 g

Order no. ★★★★★★
ro1045 kit San Diego

RC functions
Rudder control, engine control

The complete accessory recommendations can be found in the construction-manual for the model.

Optional accessories for Radio Control

- rof2201 2-channel remote control 2.4 GHz
- 79054 Servo for rudder
- 42260 Max Speed 800 electric motor 2x
- 67052 Cruise control Quicrun WP860 Dual
- 42128 Suppressor kit 2x
- ro1446 High load coupling 2x

ro1046 Optional hardware kit San Diego



 **Made in Germany**



Spare Parts

- ro4137 Z-Drive with coupling
- ro1311 Lifejacket
- ro1500 Life raft
- ro1302 Radar head
- ro1300 Radar
- ro1353 Ship bell
- ro1401 Windlass
- ro1362 Flag USA 2 pcs.

DOLLY HARBOR BARGE

This type of ship is used universally in many ports around the world. Depending on the design, these barges are used to transport people or materials, but can also be used with special equipment to tow ships or as fire boats. With an electric motor fitted and the single-screw drive, the Dolly can be driven true to the original. The very good maneuverability results from the tunnel formed in the hull. The model can be equipped with a special function set as a fire boat with extinguishing cannon, water pump, etc. Another possibility is the construction of a towing harness for use as a small harbor tug.

The Dolly is easy to build, but is a great basis for many modelers to customise with their own ideas because of its universal use.

Kit Contents

The kit contains the preformed hull, the preformed wheelhouse made of transparent material (this does not require cutting out of the windows) and other superstructures and fittings as well as the deck cut out with laser. The complete steering gear, stern tube with prop shaft, propeller and coupling. Self-adhesive decals, multilingual construction manual and drawings.

The fittings kit contains working lights and all fittings such as ventilators, bollards and much more.

Accessories

Order no.

ro1006 Fittings kit Dolly

ro1009 Special function set fire monitor

Alternatively:

ro1434 Towing gear

Scale

1:20

Length about

550 mm

Width about

165 mm

Total displacement about 1200 g

Order no. ★★☆☆☆☆

ro1005 Construction kit
harbour barge Dolly

Required accessories

for operation with remote control

Order no.

42235 Electric motor Max Speed 400

42128 Suppressor kit

67051 Speed control Quicrun 1060

79054 Rudder servo

Remote control from 2-channel

(with special function from 4-channel)



Made in
Germany

RC-
Model

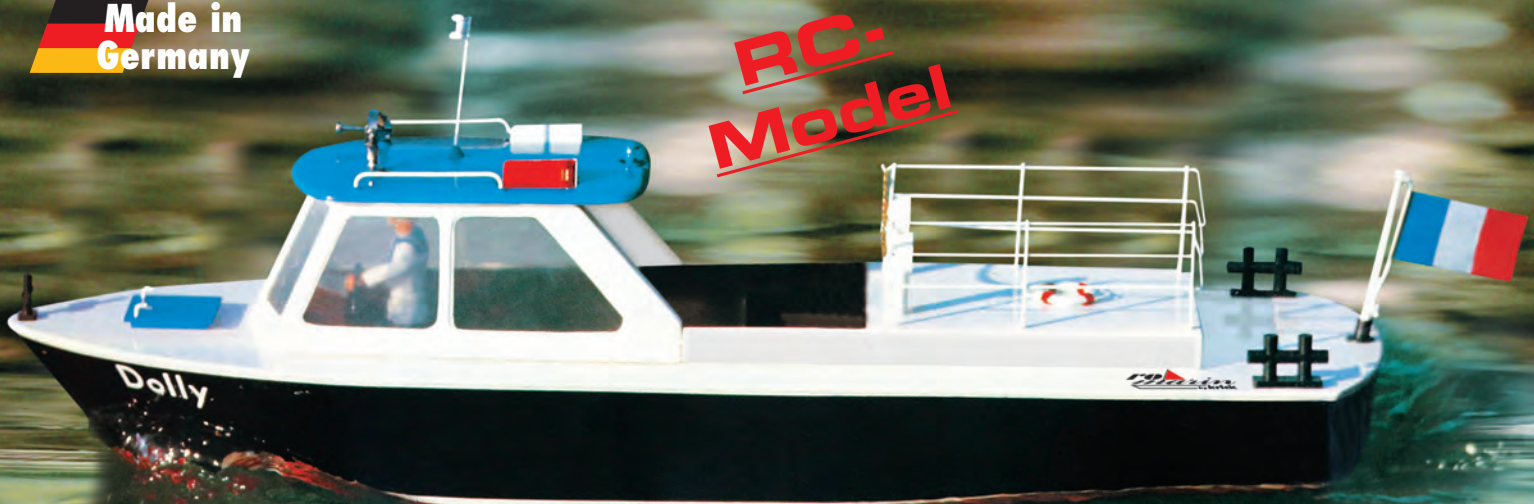

For special functions further accessories required, information at www.krick-modell.de

PAULA REMOTE CONTROL MODEL OF A WORKING BOAT WITH CRANE IN SCALE 1:25

In many ports of the world you can meet the originals of our Paula. They eagerly leave the harbor to serve in the coastal area, at the mouths of the great rivers and at the entrances to the ports. They are agile for their size and as very manouverable work boats are universally used. Tasks include the collection and disembarkation of nautical symbols, the elimination of small obstacles in the shipping channels or the transport of specialized marine research equipment. Thus result a big variety of uses for this boat for the resourceful modeller. The Paula is the ideal model for the beginner and advanced, who still wants to do real model making. The recommended lead-acid battery can be used for long periods of use. The overhead crane can deposit and pick up loads across the rear of the model.



RC-Model



Made in Germany

Kit Contents

- ABS hull and deck vacuum formed
- Laser cut superstructure including windows of transparent material and window frames
- Laser cut components for the interior of the hull
- Complete steering gear
- Stern tube with shaft and propeller
- Shaft coupling
- All parts for the crane
- Decal sheet
- Construction manual with drawings
- Complete fittings kit

Accessories

- ro1537 Special function set for crane Paula
- ro1539 Buoy kit set (2 pieces)

Propulsion accessories

- 42124 Electric motor Max Power 600
- 42128 Suppressor kit
- 67051 Speed control Quicrun 1060
- 79054 Rudder servo
- Remote control from 2-channel
(for use with special functions 4-channel radio is required)

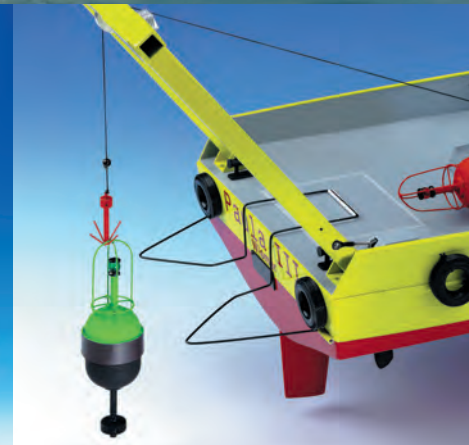

Scale 1:25
Length about 710 mm
Width about 215 mm
Total displacement about 2500 g

RC functions

Rudder control, engine control, special functions

Order no. ★★☆☆☆☆
ro1159 Construction kit workboat Paula



For special functions further accessories required, information at www.krick-modell.de

NEPTUN THE TUG BOAT

The Tug Boat Neptun is a remote controlled model of a tug boat in 1:50 scale as they are still found in many ports. Model of this construction were harbour tugs of the Bugsier series in Hamburg. In the construction of the model much emphasis was placed on true to scale and lovingly executed details. On the lower mast platform is a functioning, rigid fire extinguisher. The Neptune is particularly manoeuvrable thanks to the swivelling Kort nozzle, so that all difficult towing and manoeuvring operations are easily executed. The towing hook can also be opened by remote control. The separate fittings kit contains all of the components for detailed fitting of the model, e.g. Anchor, windlass, bollard, life raft, illuminated top and position lights, towing winch, tire fender and many other small parts.

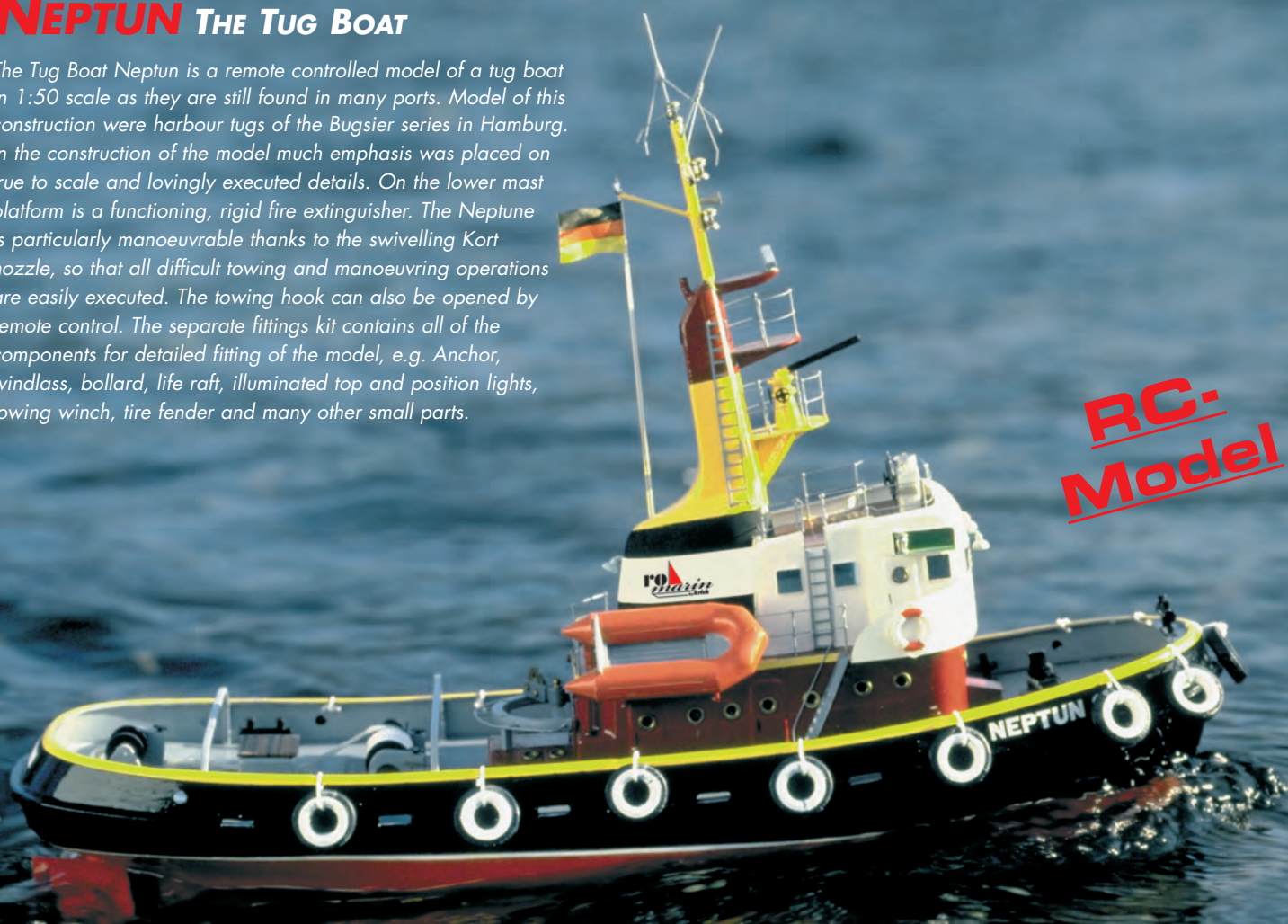

Made in Germany



Kit Contents

- Hull, bulwark, machine and wheelhouse of vacuum formed ABS plastic
- Fire monitor and other plastic hardware
- Laser cut wood parts for interior work
- Prop shaft, propeller
- Injection moulded Kort nozzle, functional towing gear and stanchions
- RC connection parts, small accessories for construction.
- Detailed fully illustrated construction manual, detailed drawings

Propulsion accessories

- ro1031 Fittings kit Neptun
- 42275 Electric Motor MAX Gear 2.5: 1
- 42128 Set of suppression capacitors
- 67051 Speed Controller WP1060
 - Battery 6 - 7.4 volts
 - Remote control from 2-channel
- 65150 Electric pump for fire monitor

Scale 1:50
Length 570 mm
Width 175 mm
Total displacement 2500 g

Order no. ★★★★★☆
ro1030 Construction kit Neptun

Antje Crabbing or Fishing Cutter

NEW RC-Model

ANTJE EXEMPLARY MODELL OF A CUTTER IN 1:25 SCALE

Of the smaller workboats on the North and Baltic Seas, cutters are the most popular for crabbing, fishing and many other jobs. Their characteristic appearance makes them extremely popular with model builders. The prefabrication of the individual components simplifies and accelerates the construction of the model.

The spacious hull offers ample space for a large battery, the drive motor and the remote control system. For detailed design, there is the fitting set no. ro1111. Especially the true to original and beautiful hull form of the Antje has motivated us to reissue this pretty model, but we also wanted to improve a lot of detail and make it true to the original. The laser technology helps us a lot to ensure more detail and make the construction easier. Thus, the new kit receives a complete laser-engraved wooden deck. Likewise the superstructures are composed of two layers of lasered plywood and some details for the interior have been added.



Made in Germany



Kit Contents

- Hull and deck made of vacuum formed ABS plastic
- Deck planking made of laser-engraved ply
- Wheelhouse and companionway made of laser cut plywood
- Masts and yards
- Steering system and linkage
- Ship propeller, shaft
- RC connectors
- Multilingual, illustrated instructions and drawings
- Boat stand

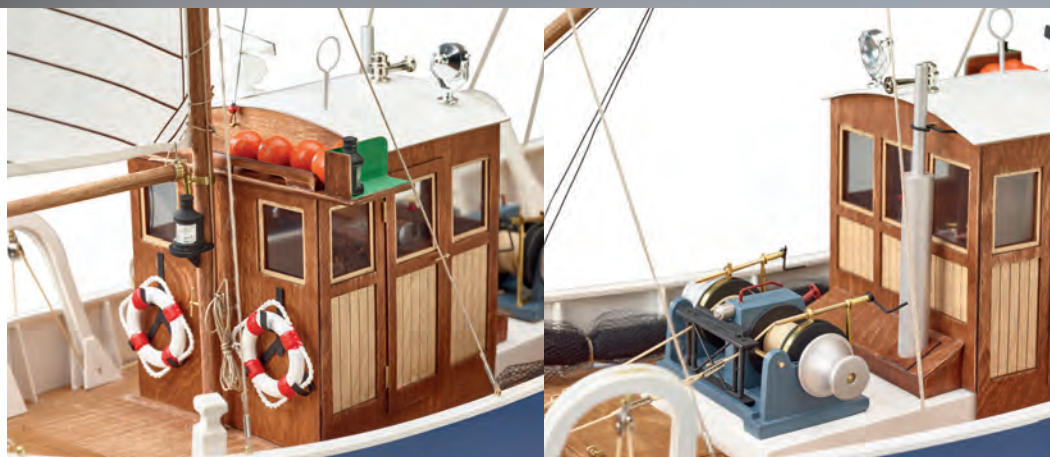

Scale 1:20
Length about 640 mm
Width about 210 mm
Height about 550 mm
Total displacement about 3000 g

RC functions

Rudder control, engine control
Special functions if required

Necessary accessories

- roF2201 2-channel remote control 2.4 GHz
- 79054 Servo for rudder
- 67051 Speed control Quicrun WP1060
- 42275 Max Gear Motor 2.5:1
- 42128 Suppressor set
- ro1449 Navy Cardan 44
- 667253 Lead battery 6 V / 3.4 Ah
- ro1111 Fittings kit Antje

Spare Parts

- ro1467 Propeller. 3 Bl. D40 R
- ro1482 Rudder 36 x 70 mm

Order no. ★★★★★☆
ro1110 Construction kit Antje

The complete accessory recommendation can be found in the construction manual for the model.

Further information can be found at www.krick-modell.de

Fireboat Düsseldorf

DÜSSELDORF SCALE MODEL OF THE FIRE FIGHTING BOAT DÜSSELDORF 1:25

The fire-fighting boat Düsseldorf was developed and built by Rheinwerft GmbH & Co., Mainz-Mombach for use in the Ruhr area of Germany. Equipped for disaster situations, be it a ship that has caught fire, spilled oil or a potentially explosive harbour installation, it can throw water or foam at 10.5 bar up to 95 m wide and 45 m high with its fire suppression monitors. The two 12-cylinder V-engines with a total of 930 kW (1260 hp) give the boat a top speed of about 37 km / h. The RO-marin construction kit of the fire fighting boat "Dusseldorf" is ideally suited in size and equipment, to showcase the diverse application possibilities of the original boat in the model. The fire monitors, the crane, the windlass, the radar, the searchlights, the blue light, the horn and the siren as well as the diesel sound can all be fully functional.



Kit Contents

- Vacuum formed hull, body and other components made of plastic
- Laser cut plastic decks and small parts
- Laser cut plywood parts, e.g. Motor frame and pump plate
- 3 working fire monitors
- Movable boat crane
- 3 propellers and 4 rudder sets as well as connection parts necessary for RC installation
- Spray paint window masking
- Decal sheet
- Detailed building instructions and plans

Scale

1:25

Length about 1160 mm

Width about 250 mm

Height about 500 mm

Total displacement about 9000 g

RC functions

Rudder control, motor control, lighting functions, special functions, sound function

Order no. ★★★★★☆

ro1100 Construction kit fire boat
Düsseldorf

RC- Model

The thick-walled plastic hull is large enough to accommodate the numerous units for all special functions. Two proven Max Gear motors give the model a reasonably high speed. Four large rudders guarantee extreme manoeuvrability for forward and reverse travel. The fire monitors can be swivelled horizontally and vertically via the remote control. They can spray far with the recommended electric gear pump. With the boat crane, the deep-drawn rowing boat can be lifted true to size and lowered outboard.

The kit contains the preformed hull, the preformed wheelhouse made of transparent material (which does not require cutting out of the windows) and other laser-cut internals. Complete with steering gear, stern tube with prop shaft and propellers. Self-adhesive images and cover masks. Multilingual construction manual with detailed plans.



 **Made in
Germany**



Accessories

- ro1101 Fittings kit Düsseldorf
- ro1103 Special function set Düsseldorf

Required accessories for sailing

- 42275 Electric Motor Max Gear 2.5: 1 (2 pieces)
- 42128 Suppressor set (2 pieces)
- 63706 Coupling (2 pieces)
- 67052 Speed control Quicrun 860 Dual
- 79050 Rudder servo
- Remote control from 2-channel
(with special function from 4-channel)

HAPPY HUNTER SALVAGE TUG

The Happy Hunter is the detailed replica of a Dutch offshore and Salvage vessel. The model is driven directly, without gear reduction, by two low-speed Max Power 700 high-torque electric motors on two high-performance propellers. Fixed Kort nozzles are used to increase the thrust.

Even the most difficult towing and manoeuvring can be performed in conjunction with the optionally available bow thruster. The spacious plastic hull allows the installation of numerous special functions. Experienced modellers will equip the Happy Hunter with working lights, radar, windlass, sound and towing equipment. Also the fully functional working of the crane is possible.

**RC-
Model**

Kit Contents

- Hull and superstructure parts made of white, vacuum formed ABS plastic
- Deck and body parts made of laser parts
- Mounting parts for drive and electronic components made of laser parts
- Complete steering gear
- Kort nozzles made of injection-moulded plastic
- Small parts for assembly
- Injection-moulded parts for the front and main mast, crane etc.
- Decal sheet
- Construction manual and assembly drawings and photos
- Boat stand



Accessories:

- ro1107 Fittings kit Happy Hunter
- ro1108 Drive set Happy Hunter with motors, couplings and accessories
- 67052 Speed control WP860 Dual
- rb108-05 Bow thruster
- Remote control from 2-channel

Scale 1:50
Length about 1035 mm
Width about 235 mm
Total displacement about 9500 g
Draft 120 mm

Order no. ★★★★★☆
ro1106 Construction kit Happy Hunter

Sailing Yacht Comtesse **NEW**



COMTESSE SAILING YACHT

The Comtesse is the image of a typical sailing yacht of the 70s and 80s. These rugged, mostly GRP boats still make up the classic image of marinas across Europe. There are numerous models from diverse shipyards and on the basis of this shapely hull many original yachts can certainly be modelled and equipped with numerous individual details.

At the same time, this shapely yacht offers very good sailing characteristics for the demanding sailor and is ideal for a relaxed afternoon at the lake. Thanks to its streamlined hull with moulded keel fin, the elegant Comtesse achieves remarkable speeds in light wind conditions. But even with stronger breezes can be easily sailed, as it is a capsizesafe keel boat. With its simple design and balanced handling, it will make it much easier for newcomers to model sailing. With Comtesse, of course, all courses, from "cruising" against the wind to sailing "in front of the wind", can be sailed effortlessly using the rudder and the sail adjustment, so that any point can be controlled and then sailed back to the starting point.

The fittings set contains many visible fittings such as lamps, wheel and parts for the steering column, winches, stanchions and more. The pictured wing keel is an optional part that significantly improves the sailing characteristics and righting moment of the Comtesse. This keel is also a good option for many other sailboats.

Kit Contents

- One-piece ABS hull (no bonding of the hull and deck required) with integral keel fin
- Deep drawn cockpit and sliding hatch
- Lasered frames and parts for interior work as well as sliding hatch and boat stand
- Ready-to-install plastic rudder with shaft
- Ready-cut sail, one-piece aluminum mast, aluminum booms
- All fittings for the sail
- Detailed construction manual

Lenght about	950 mm
Width about	230 mm
Height about	1500 mm
Total displacement	3200 g
Mast height about	1200 mm
Sail area	30 dm²
Draft	210 mm
Ballast content	1800 g

RC-functions

Rudder control, Sail adjustment

RC-Model



Optional Accessories

- ro1073 Fittings set Comtesse
- ro1071 Winged keel
- roF2201 2-channel remote control 2.4 GHz
- 79054 Servo for rudder
- 79073 Sailing winch Windforce 1006MG
- 60108 Ballast (0,5 kg) 4x



Order no. ★★☆☆☆
ro1072 Sailboat kit Comtesse



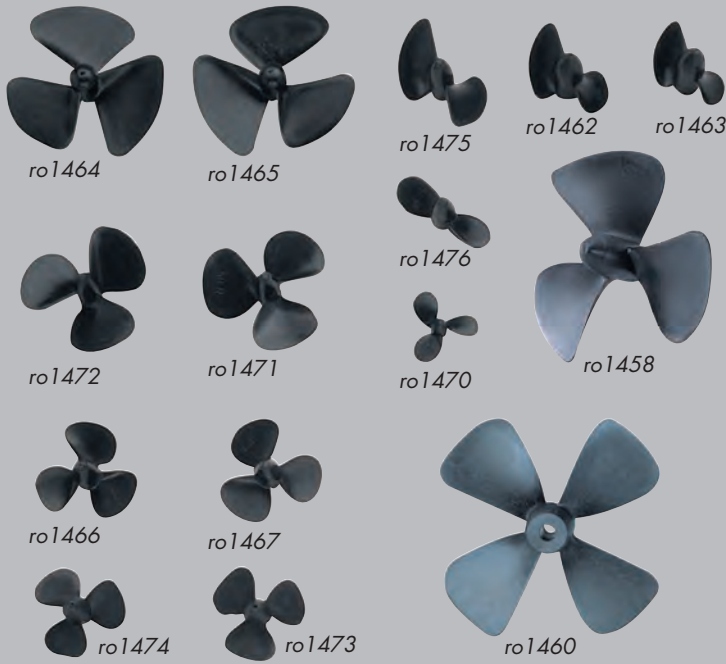

DYNAMIC PROPELLERS

Order no.	Ø	Blades	Thread	Pitch	R/L	Comment
ro1463	35 mm	2	M4	47 mm	right	for high Power
ro1476	40mm	2	M4	36 mm	right	for high turns
ro1462	40 mm	2	M4	40 mm	right	for high Power
ro1475	45 mm	2	M4	60 mm	right	for high Power
ro1455	30 mm	2	M4		right	Surface Prop
ro1497	33 mm	2	M4		right	Surface Prop
ro1498	33 mm	2	M4		left	Surface Prop
ro1468	42 mm	2	M4		right	Surface Prop
ro1469	42 mm	2	M4		left	Surface Prop
ro1470	30 mm	3	M2	25 mm	right	
ro1473	35 mm	3	M4	30 mm	right	
ro1474	35 mm	3	M4	30 mm	left	
ro1467	40 mm	3	M4	34 mm	right	
ro1466	40 mm	3	M4	34 mm	left	
ro1471	50 mm	3	M4	42 mm	right	
ro1472	50 mm	3	M4	42 mm	left	
ro1465	60 mm	3	M4	45 mm	right	for Kort Nozzle
ro1464	60 mm	3	M4	45 mm	left	for Kort Nozzle
ro1458	75 mm	3	M4	53 mm	left	
ro1460	95 mm	4	—	65 mm	left	Dog Drive

KORT NOZZLE 50 MM



Moving Kort Nozzle suitable for ship propellers up to 50 mm in diameter. Due to the tunnel effect at the propeller a very high maneuverability of the model is achieved.

Order no. ro1433

KORT NOZZLE SET 60 MM



Fixed Kort nozzle with propeller 60 mm and attached movable rudder, blade size 70 x 36 mm. For ship models that need the highest possible thrust. Delivery as picture.

Order no. ro1487

T-STEERING LEVER



For the steering of rudders, controllable nose landing gears (diameter 3 or 4 mm) or similar applications. The unneeded part of the lever can easily be cut off.

Order no. ro1483

SHIP'S RUDDERS

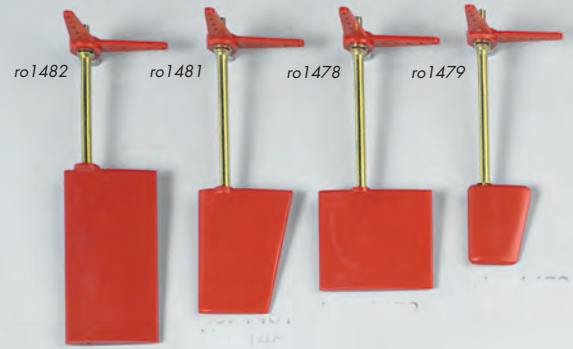

With injected shaft, coker tube, O-ring seal and L-type rudder lever

Order no.	Blade height	Blade width	Height with shaft	Application
ro1482	70 mm	36 mm	130 mm	large ships
ro1481	50 mm	36 mm	120 mm	motor boats
ro1478	40 mm	45 mm	110 mm	medium work boats
ro1479	32 mm	25 mm	102 mm	small motor boats

NAVY DIERCT 2000

Motors not included

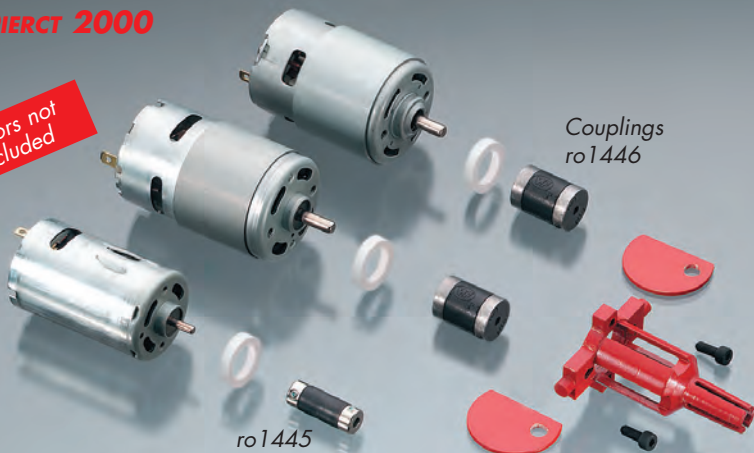

Couplings ro1446

ro1445

Direct drive with fixed connection to stern tube (6 to 7 mm diameter). With the help of the practical support semi-circles, the complete motor shaft unit can be easily supported on the ship's bottom and glued together at the same time. Can be used for almost all stern tubes from 6 to 7 mm in diameter and engines from 500 to 800 class. Includes mounting unit with support washers, plastic centering rings for 500, 600 and 700/800 motor sizes, locking nut, engine mounting screws and instructions.

Order no. ro4100

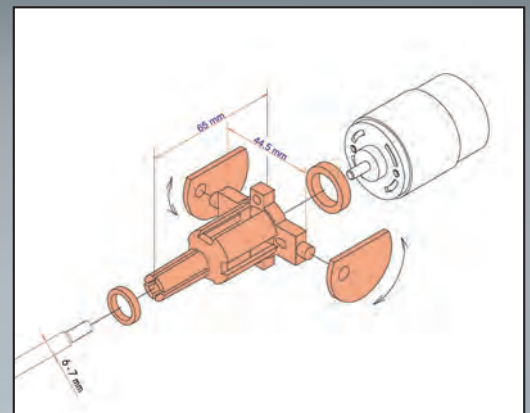

Prop shafts see next page

ro1441 to ro1444

PROP SHAFTS

Stern tubes with plain bearings and stainless steel shafts with thread on one side

zu ro1452
(with 3-blade-propeller 30 mm Ø right and collar)

Order no.	Shaft-Ø	Thread	Shaft Length	Stern Tube-Ø	Stern Tube Length
ro1444	4 mm	M4	300 mm	6 mm	232 mm
ro1443	4 mm	M4	260 mm	6 mm	195 mm
ro1442	4 mm	M4	223 mm	6 mm	175 mm
ro1441	4 mm	M4	130 mm	6 mm	90 mm
ro1452	2 mm	M2	160 mm	4 mm	110 mm

SHAFT LUBRICANT



Shaft grease tube, 80g content - Good adhesion and resistant to water, acids and alkalis. Ideal for greasing shafts, prevents water from entering the stern tube.

- Extremely water resistant and water repellent
- Wide temperature range from -10 °C to +130 °C
- Friction, wear is reduced by special additives
- Protecting against corrosion
- Suitable for sliding and rolling bearings
- Made in Germany
- No water hazard

Order no. ro5557

Z-DRIVE WITH COUPLING



The practical drive unit for fixing to the rear of the fuselage of the model. In many Robbe speedboats this agile drive is used.
Prop Ø 42 mm,
Total height 76 mm
Shaft Ø 4 mm

Order no. ro4137

Spare propeller
Order no. ro1468

NAVY KARDAN 44



Shaft offset compensation approx. 2 mm. For shafts with 4 mm and 3 to 3.2 mm Ø (with reducer)
Total length with center piece 54 mm, without center piece 38 mm

Order no. ro1449

NAVY KARDAN 35



The classic plastic cross joint with brass inserts, metal center piece and stainless steel grub screws.
For shafts with 4 mm and 3 to 3.2 mm Ø (with reducer) total length 38 mm

Order no. ro1596

KEEL RUDDER

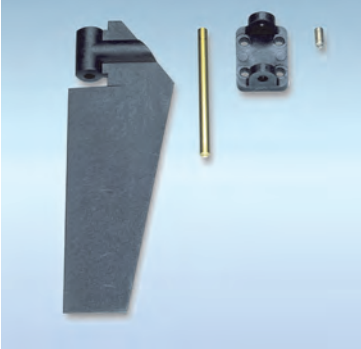

Keel Rudder
For Off Shore boats
Rudder blade length 86 mm
Order no. ro1477

KEEL RUDDER PIVOTING



For racing boats. When touched by obstacles, the rudder blade automatically swings up.
Total height about 65 mm
Order no. ro1490

ÖILER FOR STERN TUBES



These handy oil fillers can easily be placed around your stern tube and tightened. Then you drill the filling hole through the oiler into the stern tube. Now a piece of silicone tubing can be attached to fill in oil or grease.

Order no.
65250 oiler for 6 mm stern tube
65252 oiler for 8 mm stern tube

NAVY-DIRECT COUPLINGS



Precise rigid couplings for connecting different shaft diameters, made of aluminum, with grub screws. Outside Dia. 11 x 17 mm

Order no.	Dia.	to	Dia.
ro1447	3,17mm		4,0 mm
ro1748	4,0 mm		4,0 mm
ro1450	5,0 mm		4,0 mm

COUPLING HOSE



Connects shafts from 1.5 to 3.0 mm in diameter. Flexible, robust, smooth running. Length 50 mm

Order no.
ro1386 pack of 10 pcs.

ELASTIC-COUPLING



For shaft connections from 4 or 3.2 mm to 3 or 4 mm (with reducer). Smooth running due to strong rubber compound. With stainless steel grub screws. Total length 28 mm

Order no. ro1445

HEAVY DUTY COUPLING



With toothed rubber damping for high power transmission
Available in 2 versions
Order no.
ro1446 or shaft connections 5 or 4 mm on 4 or 3.2 mm (with reducers)
ro1436 for shaft connections 5 to 5 mm (not shown)

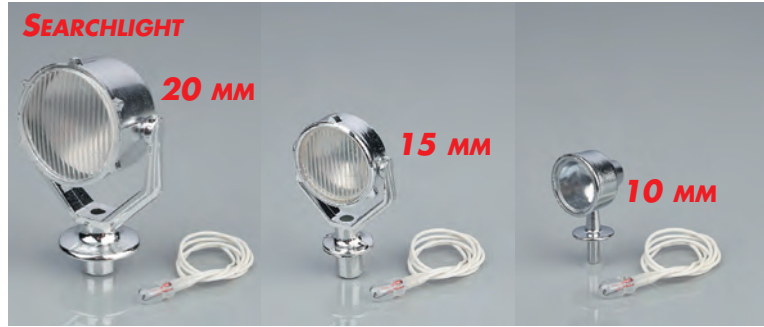

SEARCHLIGHT

Functional, with micro-bulbs 6 V / 100 mA

Ø 20 mm	Ø 15 mm	Ø 10 mm
Height 34 mm	Height 24 mm	Height 15 mm
Order no. ro1374	Order no. ro1640	Order no. ro1641

pack of 2



DECK LAMP

With curved mounting arm and reflector screen, with micro-bulb 6 V/50 mA, shield-Ø 9 mm

Order no. ro1642

pack of 2



HALOGEN DECK SPOTLIGHT

With mounting base and microbulbs 6 V/100 mA 14 x 10 mm

Order no. ro1375

pack of 2



RED, YELLOW, BLUE LIGHT

Colored glass with aluminum base and microbulb 6 V / 50 mA, Ø 8,8 mm, height 19 mm

Order no. ro1647 red light pk 1 pc.
Order no. ro1649 yellow light pk 1 pc.
Order no. ro1648 blue light pk 1 pc.



PANORAMIC LAMP

Housing made of transparent plastic unpainted, microbulbs 6V/50mA Ø 7 mm, height 9.5 mm

Order no. ro1646

pack of 2



NAVIGATION LAMP SET YACHT

Made of transparent plastic with colored micro-bulbs, for the faithful illumination of ships, right green, left red, clear front and rear, micro-bulbs 6V/50 mA. 4 pcs. lamp housing unpainted 7 x 9.5 mm

Order no. ro1592



NAVIGATION LAMP SET
with microbulbs 6 V/50 mA

Made of brass with colored micro-bulbs, for the faithful illumination of ships, right green, left red, clear in front and rear. 4 pcs. Lamp housing unpainted 7 x 9.5 mm 2 pcs. Lamp board unpainted

Order no. ro1643



NAVIGATION LAMP SET

For the faithful lighting of larger ship models, 6 V / 50 mA, right green, left red, clear front and rear, incandescent lamps with 800 mm strand length, lamp housing Ø 10 x 20 mm

Contents: 2 + 2 lamp housings, 4 bulbs (red, green, 2x clear)

Order no. ro1383



RIGHT OF WAY LAMP SET

Contains 3 all-round lamp housings Ø 10 x 20 mm, 3 lamp glasses, 3 bulbs (1x clear, 2x red), 6 V / 50 mA, 800 mm strand length

Order no. ro1414



PANORAMIC LAMP SET

Suitable for bulbs with Ø 3 mm

Order no. ro1411 (2 pieces)



DOUBLE PANORAMIC LAMP

Housing made of transparent plastic, unpainted, can also be cut to a simple lamp. With microbulbs 6 V / 50 mA Ø 5.4 mm, height 12 mm

Order no. ro1645

pack of 2



SET LAMP SHELVES

Suitable for ro1413 or ro1383

Order no. ro1408 (1 pair)



SET MAST LAMP SUPPORT

Fits ro1412, ro1383 or smaller lamps

Order no. ro1409

pack of 4



LAMP SET TOP LIGHT

Suitable for bulbs with Ø 3 mm

Order no. ro1412

pack of 2



LAMP SET SIDE LIGHTS

suitable for bulbs with Ø 3 mm

Order no. ro1413 (pack 1 pcs.)



DOUBLE TOP OR DOUBLE SIDE LAMP

Housing made of transparent plastic, unpainted, can also be cut to a simple lamp. With microbulbs 6 V / 50 mA Ø 5.4 mm, height 12 mm

Order no. ro1644 unit 2 pcs.

MINIATURE LIGHT BULBS

4 colors, Ø 2.3 mm
Cable length 100 mm



MINIATURE LIGHT BULBS

High-quality miniature bulbs with extremely small dimensions, manufactured by a special process. Shock resistant due to filament holder and therefore suitable for all areas of model making. Lifetime approx. 16,000 operating hours at rated voltage.

Order no.	Ø	Voltage	Amperage	Cable Length	Color	Pack
ro1650	2,3 mm	6 Volt	50 mA	100 mm	clear	2 pcs.
ro1651	2,3 mm	6 Volt	50 mA	100 mm	red	2 pcs.
ro1652	2,3 mm	6 Volt	50 mA	100 mm	green	2 pcs.
ro1653	2,3 mm	6 Volt	50 mA	100 mm	yellow	2 pcs.
ro1659	2,3 mm	6 Volt	50 mA	100 mm	clear	50 pcs.
ro1660	2,3 mm	6 Volt	50 mA	100 mm	red	50 pcs.
ro1661	2,3 mm	6 Volt	50 mA	100 mm	green	50 pcs.
ro1662	2,3 mm	6 Volt	50 mA	100 mm	yellow	50 pcs.
ro1654	3 mm	6 Volt	50 mA	100 mm	clear	2 pcs.
ro1655	3 mm	6 Volt	50 mA	100 mm	red	2 pcs.
ro1656	3 mm	6 Volt	50 mA	100 mm	green	2 pcs.
ro1657	3 mm	6 Volt	50 mA	100 mm	yellow	2 pcs.
ro1663	3 mm	6 Volt	50 mA	100 mm	clear	50 pcs.
ro1664	3 mm	6 Volt	50 mA	100 mm	red	50 pcs.
ro1665	3 mm	6 Volt	50 mA	100 mm	green	50 pcs.
ro1666	3 mm	6 Volt	50 mA	100 mm	yellow	50 pcs.
ro1671	3 mm	6 Volt	50 mA	800 mm	clear	2 pcs.
ro1669	3 mm	6 Volt	50 mA	800 mm	red	2 pcs.
ro1670	3 mm	6 Volt	50 mA	800 mm	green	2 pcs.
ro1658	3 mm	6 Volt	100 mA	100 mm	clear	2 pcs.
ro1410	3 mm	6 Volt	100 mA	800 mm	clear	2 pcs.
ro1667	3 mm	6 Volt	100 mA	100 mm	clear	50 pcs.

MINIATURE LIGHT BULBS

4 colors, Ø 3 mm
Cable length 100 mm



MINIATURE LIGHT BULBS

3 colors, Ø 3 mm
Cable length 800 mm



FIRE MONITOR 1:25



Model replica of a fire monitor, horizontally and vertically swiveling. Can be made functional. Easy assembly due to red-colored molded parts and metal pipes. Can be used on many models.

Order no. ro1562 Fire Monitor 1:25

CONTROL DISC SET

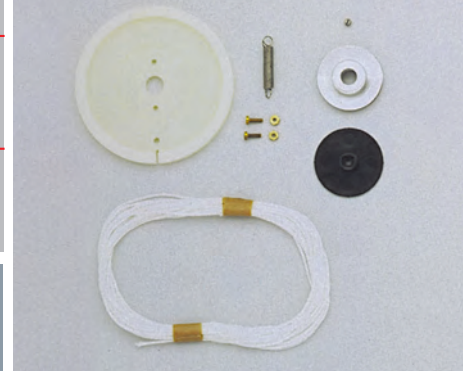

Serves for the proportional pivoting of cranes, fire monitors, guns, etc. The gear ratio (3:1) increases the swing range of a normal servo from 90 to 270°. The large disc with a diameter of 60 mm is fixed on the servo, the small disc on the object to be rotated. Very simple installation, also later.

Order no. ro1560 Control Disc Set

CRANE 1:25 & CRANE 1:50

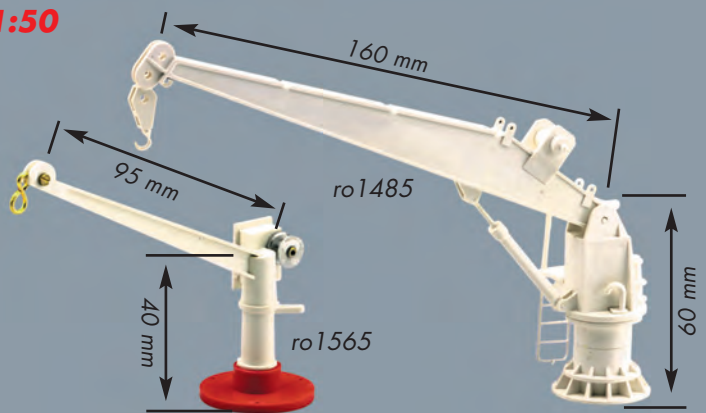

Crane 1:25 - The original-like crane consists of three molded plastic parts. It can be mounted without great construction effort, can be swiveled horizontally and has a crane hook that can be raised and lowered.

Order no. ro1565

Ship Crane 1:50 - Suitable for tugs and similar models. Finely detailed, true to the original design. Movable horizontally and vertically, crane hooks can be moved up and down. Consisting of 13 plastic molded parts and mounting accessories. A decoration set is included.

Order no. ro1485

TOWING GEAR



Functional towing gear made of plastic. The towing hook can be opened with a servo. All pictured parts included.

Width about 77 mm
Length about 50 mm
Height about 30 mm

Order no. ro1434



WATER PUMP



Order no. 65150 Water Pump 6 - 12 V
o.Abb. 70917 Silicone tube
3,5 x 5,5 x 1000 mm

RUBBER DINGHI 1:50



Cast from resin
Length about 98 mm
Order no. ro1489

RUBBER DINGHI 1:25

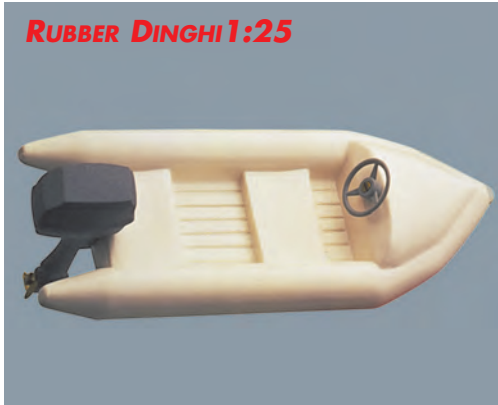

Blown from ABS, buoyant, with outboard motor and steering wheel, length 140 mm
Order no. ro1577

LIFERAFT/LIFEJACKETS



Liferaft
Orange colored, can be found on any ship in different sizes. Dimensions 17 x 37 mm
Order no. ro1501 pack of 2 pcs.
Lifejackets colored yellow for yachts
Order no.
ro1376 Width 28 mm 1:20 pack of 4 pcs.
ro1311 Width 22 mm 1:25 pack of 4 pcs.

OUTBOARD MOTOR DUMMY

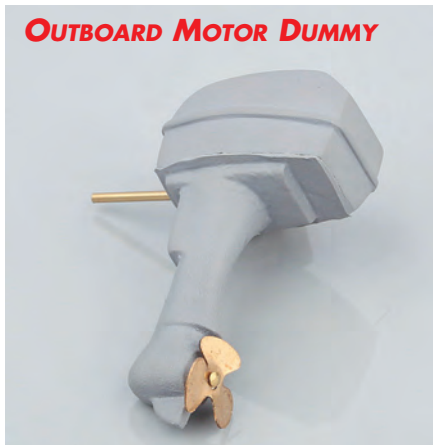

Molded from gray plastic, with propeller
Scale 1:25, height approx. 60 mm

Order no. ro1404 outboard engine dummy

LIFERAFT BASE



Suitable for ro1500
Scale 1:25

Order no. ro1517



LIFERAFT

Scale 1:25
Length 57 mm

pack of 4 pcs. Order no. ro1500

pack of 2 pcs.

RADAR EQUIPMENT

Suitable for functional turning of the bar. For this purpose the geared motor 300:1, Order no. 42203, can be used well with an extended axis.

TYPE W3 1:25

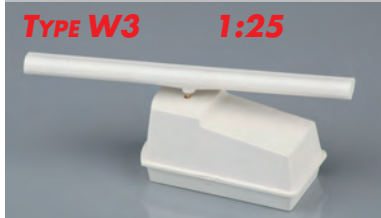

Beam width 73 mm
Body 40x20 mm
Order no. ro1301 pack of 1 pcs.

TYPE HH 1:25



Beam width 73 mm,
Body 20x10 mm
Order no. ro1484 pack of 1 pcs.

TYPE BERLIN 1:25



Beam width 80 mm,
Body 19x7,5 mm
Order no. ro1300 pack of 1 pcs.

RADAR EQUIPMENT 1:25

without function



Ø 35 mm Ø 20 mm
pack of 1 pcs. pack of 1 pcs.
Order no. ro1302 Order no. ro1305

BITTS injection molded black plastic

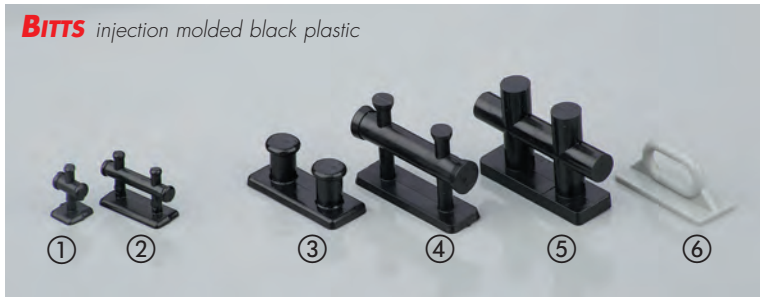

Order no.	Length	Height	Figure	Shape	Pack
ro1345	28 mm	18 mm	5	Double Cross Bitt	6 Stück
ro1344	25 mm	17 mm	4	Double Cross Bitt	6 Stück
ro1343	14 mm	9 mm	2	Double Cross Bitt	6 Stück
ro1348	6 mm	9,5 mm	1	Cross Bitt	6 Stück
ro1350	22 mm	9 mm	3	Double Bitt	6 Stück
ro1342	20 mm	9 mm	6	Cable Guide	5 Stück

CLEATS injection molded black plastic



Order no.	Length	Height	Fig.	Shape
ro1340	15 mm	6 Stk.	1	cleat
ro1341	25 mm	6 Stk.	2	cleats for screwing
ro1338	22 mm	6 Stk.	3	yacht bollards

CABLE HAWSE



2-piece oval jaws for large models
Width 18 mm
Length 23 mm
Height 14 mm

Order no. ro1406 unit 4 pcs.

STEERING WHEELS / HAND WHEELS



Made of grey plastic

Order no.	Ø	Pack	Comment	Fig.
ro1329	40 mm	1 pcs.	steering wheel	1
ro1330	20 mm	4 pcs.	steering wheel	2
ro1331	10 mm	10 pcs.	hand wheel	3
ro1755	5 mm	10 pcs.	hand wheel	4

STEERING WHEEL 60 MM



Detailed steering wheel for sailboats, plastic, diameter 60 mm

Order no. ro1514 Pack 1 pc.

STEERING WHEEL 120 MM



True to original steering wheel for large sailing yachts, also usable as other spoked wheel. Plastic, diameter 120 mm

Order no. ro1760 Pack 1 pc.

STEERING WHEELS



Pk. 1 pcs. Pk. 1 pcs.

Order no.
ro1756 steering wheel 36 mm, 3 spokes
ro1757 steering wheel 35 mm, 2 spokes

DOORS



Doors 54 x 25 mm made of plastic, 3 pairs left and right

Order no.
ro1553 Doors for porthole
ro1554 Doors without holes

COMPASS HOOD

FOGHORN



Order no. Pack 2 pcs.

ro1393 compass hood
ro1399 foghorn 24 mm
ro1398 foghorn 15 mm

VENTILATORS



Made of plastic

Order no.	Ø	Pack	Type	Fig.
ro1405	2,2 mm	6 pcs.	Gooseneck	1
ro1416	4,5 mm	6 pcs.	Gooseneck	2
ro1419	6 mm	6 pcs.	Ventilator	3
ro1333	15 mm	6 pcs.	Ventilator 35 mm	4

VENTILATORS



Gooseneck

24 x 13 mm
Order no. ro1418
Pk. 6 pcs. ①

Suction fan

27 x 18 mm
Order no. ro1332
Pk. 6 pcs. ②

LIFESAVER



Molded of white plastic

Order no.	Diameter	Pack
ro1334	20 mm	6 pcs.
ro1335	25 mm	6 pcs.
ro1336	33 mm	4 pcs.

TYRE FENDERS



Order no. ro1337 Pack 10 pcs.

FLAGS

Made of fabric, with rope and metal clamp, each 1 piece, 25 x 40 mm and 15 x 30 mm



Order no.	Motiv
ro1359	Flag Germany
ro1360	Federal Service Flag
ro1361	Flag France
ro1362	Flag USA
ro1363	Flag United Kingdom
ro1364	Flag Italy
ro1365	Flag Norway

Order no.	Motiv
ro1366	Flag Sweden
ro1367	Flag Denmark
ro1368	Flag Netherlands
ro1370	Flag Belgium
ro1371	Flag Austria
ro1372	Flag DGZRS
ro1394	Flag Japan

RUBBER BELLOW



Rubber Bellow for water tight linkages on boats
Length 50 mm
Super soft, made in Germany

Order no. ro1400 Pack 2 pcs.

TRIM FLAP SET



Trim Flap Set
For racing boats, adjustable with Right / left-hand thread and lock nut
Size of the sheet 32 x 23 mm
Order no. ro1352

COMPANIONWAYS



made of grey plastic
Order no. width height Pack
ro1328 20 mm 80 mm 4 pcs.
ro1327 15 mm 80 mm 4 pcs.

LADDER

NEW

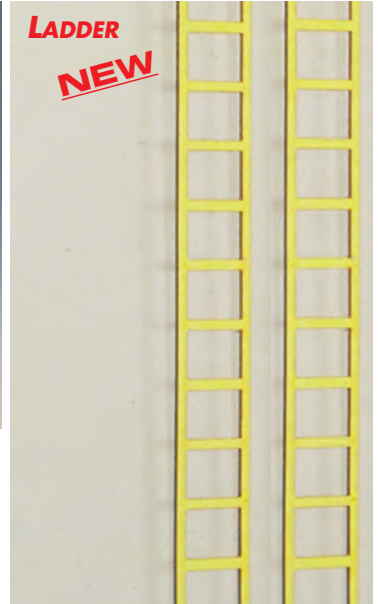

Brass ladder, ideal for soldering, width 9 mm, step distance 6 mm, length approx. 250 mm
Order no. ro 1425 Pack 2 pcs.

SHIP'S BELL

NEW



Turned of brass, diameter 14 mm
Order no. ro 1353 Pack 2 pcs.

SPEAKER

NEW

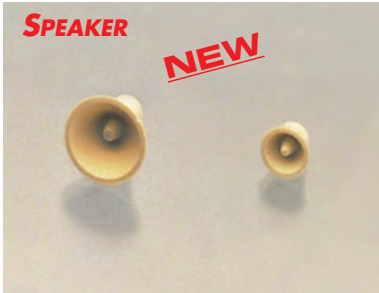

Made of plastic, 5 mm and 13 mm diameter, each 2 pieces
Order no. ro1304

WINDLASS 1:50

NEW



As used on model Happy Hunter, suitable for many models.
Made of resin, rotary and laser parts.
Dimensions 58 x 38 x 25 mm, scale 1:50

Order no. ro1354

STANCHIONS FLAT

NEW



True to the original flat design, made of brass, ideal for soldering or gluing.

Order no.	Length	Qty.	Holes
ro1313	15 mm	1	
ro1314	40 mm	2	wide
ro1315	40 mm	3	
ro1316	40 mm	2	tight
ro1317	60 mm	4	

MANHOLE COVER



Movable, suitable for e.g. concealed mounting of On/Off switch, Dia. 29 mm
Order no. Pack
ro1518 manhole cover 2 pcs.

DYNAMIC PROPELLER

NEW



2-blade surface propellers used as a pair at Sea Jet Evolution.
Diameter 33 mm, thread M4

Order no. direction of rotation
ro1497 right
ro1498 left

RUBBER PROFILE

NEW



Half-round rubber profile for Sea Jet and other models as sheer rail for plugging or gluing.
Length about 300 cm
Order no. ro10664000



DRIVER FIGURE

NEW



Multi-part driver's doll made of ABS plastic, unpainted white, not glued,
Scale about 1:4, used on model Sea Jet Evolution
Order no. 10661000

WING KEEL

NEW



For improving the sailing characteristics and righting moment of sailing yachts like the Comtesse.

Cast metal, weight about 850 g,
Measures about 80 x 140 x 20 mm

Order no. ro1071 pack 1 pc.

CARBINE HOOKS

NEW



For simple rigging of sheet on sailboats, length 12 mm, load about 15 kg

Bestell-Nr. ro1759 pack 8 pcs.



ALU-PROFILE MAST
9x19x1800 MM

Drawn aluminum mast profile with groove, for larger ship models from 1 m in length

Order no. ro1079



ALU MAST AND BOOM PROFILE
8x12x1000 MM

Suitable as a mast profile for smaller models and as a boom profile for fore and main sail.

Order no. ro1116



ALU-PROFILE MAST
ROUND 11 MM

Order no.
ro1526 Profilmast 1000 mm long
ro1527 Profilmast 1620 mm long

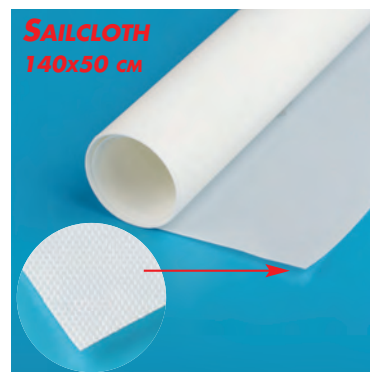

SAILCLOTH
140x50 CM

High quality polyester cloth 127 g/m², light and stiff, without structure suitable for classic and modern sailboats. The format 140 x 50 cm is chosen so that it is sufficient for most models for main and fore sail.

Order no. 61905



RIGGING WIRE
STAINLESS STEEL

Highly flexible stainless steel wire for shrouds and stays

Order no.
ro1758 Rigging wire 0,5mm, 10 m
ro1321 Rigging wire 0,8mm, 10 m



CRIMP SLEEVES

For looping at the end of steel wire shrouds and stays Pack 20 pcs.

Order no.
ro1318 Crimp sleeves
1,4mm f. wire 0,5 mm
ro1319 Crimp sleeves
2,0mm f. wire 0,8 mm



MOUNTING BRACKET

Made of aluminum for attaching to masts and booms with 2 screws. The second end with free bore can be angled angular or vertically, be used to attach a leash, shroud or stay. Dimension 5 x 25 mm, holes 2 mm

Order no. ro1357 Pk.10 pcs.

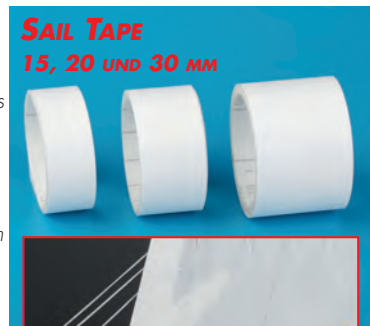

SAIL TAPE
15, 20 UND 30 MM

Self-adhesive fabric tape for reinforcing or edging sails in three different widths

Order no. Pack 2 pcs.
61907 1,5 x 136 cm
61908 2,0 x 136 cm
61909 3,0 x 136 cm



ROTATING SWIVEL

With ball bearing for easy and free rotation of ropes with high tensile strength Diameter 6 mm, with two rings each

Order no. ro1320 Pack 2 pcs.



LINE TENSIONER

For adjusting and tensioning plastic lines on model sailboats Suitable for lines of 0.6 mm, Dimension 5 x 15 mm

Order no. ro1325 Pack 10 pcs.



S-HOOKS

Tackle hooks in S-shape made of 1.5 mm brass wire. Length approx. 12 mm

Order no. ro1326 Pack 10 pcs.



YARN OR SHEET ROPE, WHITE

For sheets of model sailing boats, water-resistant and UV-resistant. High strength at low elongation, excellent abrasion resistance.

Order no.
ro1686 0,6 mm (length 10 m)
ro1687 1,0 mm (length 10 m)



SCREW HOOKS

M2,5 x 30 mm with nuts and washers

Order no. ro6955 Pack 5 pcs.



HATCH LOCK (SHUTTER BARS)

Inconspicuous locking device for removable shutters and ship deck parts. Clear plastic, 5 x 8 mm, with screws

Order no. ro1545 Pack 10 pcs.



SHROUD TENSIONER

Turnbuckle with swivel, eye bolts at top and bottom, clevis and nut. For easy adjustment of the shroud or stay length. Thread M3, total length approx. 70 mm

Order no. ro 6088 Pack 2 pcs.

krick

Modellbau vom Besten

Klaus Krick Modelltechnik
Inhaber Matthias Krick
Industriestr. 1 · 75438 Knittlingen

Neptun



Anje



Düsseldorf



San Diego



Paula



Katja



Comfesse



For further information please ask for our main catalog in german language (20,- Euro to countries out of Germany)

For new items, videos and spare part informations visit our web site www.krick-modell.de

Your Retailer:

Order no.
92207 Romarin Catalog

