

CUTTY SARK "Le Piccole"

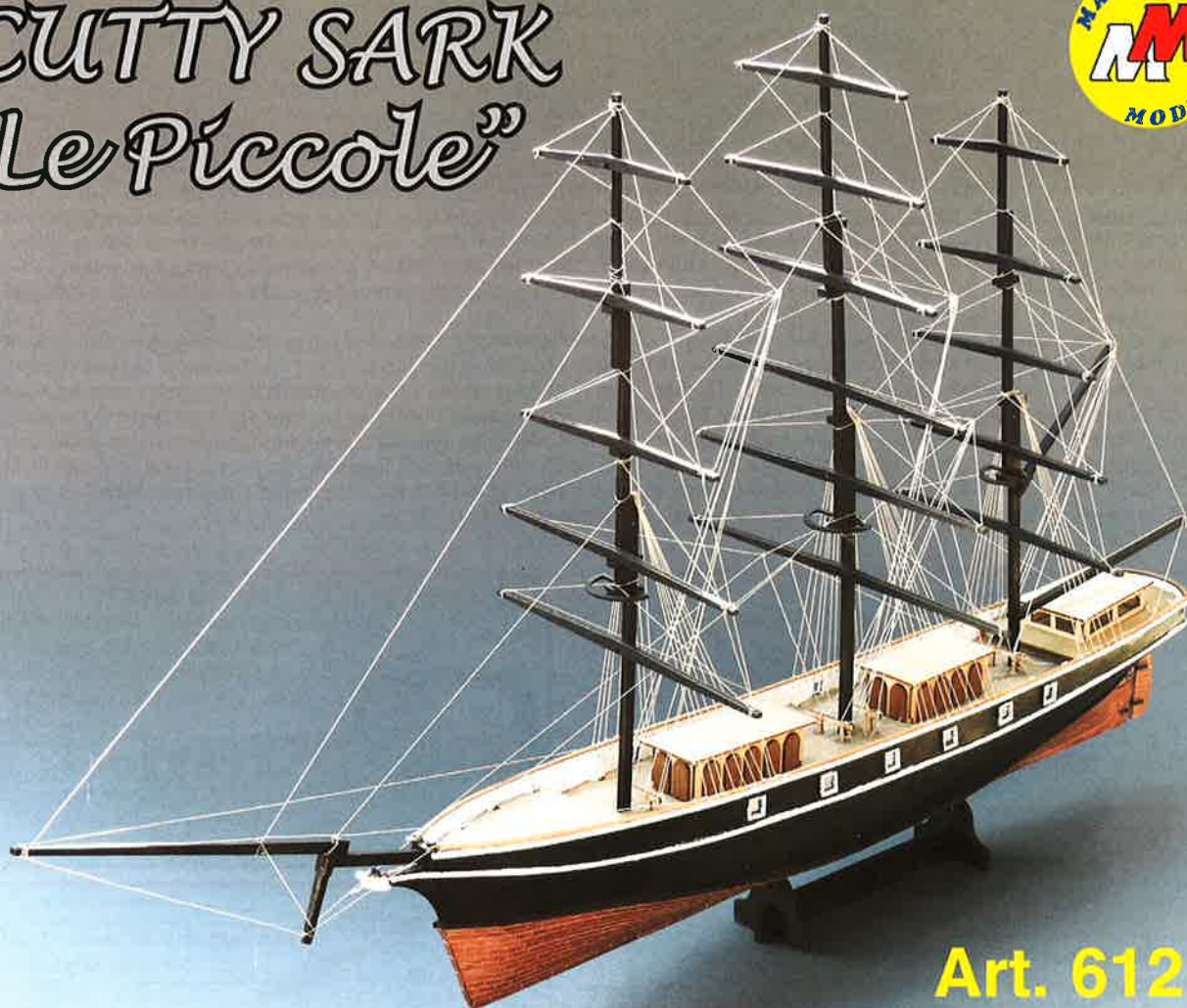

Art. 612

1015



1016



Art. 1015 SUPER-GLUE

Colla vinilica rapida
White glue
Wasserfester weißleim
Colle blanche
Witte houtlijm
Cola vinilica rápida

Art. 1016 ALI-GLUE

Colla alifatica rapida
Aliphatic glue
Wasserfester aliphaticleim
Colle aliphatique
Alifatische houtlijm
Cola alifática rápida



Cianoacrilato
Super glues
Sekundenkleber
Colles cyanoacrylates
Secondenlijm
Cianoacrilato

Art. 1565 20 gr.

Art. 1020 100 cc.

Vernice di fondo trasparente per legno
Clear primer for wood
Porenfüller, farblos für Holz
Bouche-pores pour bois
Primer & porienvuller voor hout
Barniz de fondo transparente para madera



Art. 1022 100 cc.

Stucco - Putty - Spachtel
Mastic - Vulmiddel - Masilla



**Art. 1740
Set**

Colori acrilici ad acqua per modellismo navale
Wash up acrylic paint for ship builder
Die Acrylic Farbe Seifenwasser für Schiffsmodelle
Couleurs acryliques à base d'eau pour modélisme naval
Acrylkleuren voor modelbouw-water oplosbaar
Pinturas acrílicas al agua para modelismo naval

Art. 1750 bianco - white - weiß - blanc - wit - blanco
Art. 1751 nero - black - schwarz - noir - zwart - negro
Art. 1752 giallo - yellow - gelb - jaune - geel - amarillo
Art. 1753 rosso - red - rot - rouge - rood - rojo
Art. 1754 blu - blue - blau - bleu - blauw - azul
Art. 1755 ocre - ochre - ocker - ocre - oker - ocre

Attrezzatura: Per la costruzione del primo stadio costruttivo di questo modello, lo scafo, abbiamo bisogno di alcuni attrezzi che Vi elenchiamo. Martello piccolo - Tagliabalsa con lame molto affilate - Serie limette - Rastrema listelli - Serie tamponi a carta vetrata - Carta vetrata grossa e fine - Serie spilli con testa - 6 pinzette di legno - 1 pennello. Se alcuni di questi utensili Vi dovesse mancare, li potrete acquistare dal Vostro negoziante, sulla base del catalogo attrezzistica, contenuto nella scatola.

Tools: To build this first steps of the model or hull, below is listed some of tools needed. Small hammer - Cutter with sharp blades - Set of files - Strip clamp machine - set of sanding sticks - 2 grades of sand paper - Set of headed pins - 6 pegs - one brush.

If you do not have some of these tools, you can buy them at your local hobby shop, following our tool catalogue supplied with the kit.

Werkzeug: Für den Bau der ersten Konstruktionsphase dieses Modells, dem Rumpf, benötigt man folgende unten angeführte Werkzeuge. Ein kleiner Hammer - einen Sockelschneider mit sehr scharfen Klingen - einen Satz Feilen - eine Vorrichtung zur Verjüngung der Leisten - einen Satz Schmirgelkissen - grobes und feines Sandpapier - einen Satz Stecknadeln - 6 Holzpinzetten - 1 Pinsel. Sollten Ihnen einige dieser Werkzeuge fehlen, können Sie diese bei Ihrem Händler anhand des Zubehörcatalogs, welcher Ihrer Verpackung beigelegt ist, erwerben.

Équipement: Pour la construction du premier stade de construction de ce modèle, la coque, nous avons besoin de quelques outils que nous vous énumérons: Un petit marteau - un couteau à balsa avec des lames très tranchantes - une série de petites limes - l'étai à lattes - une série de cales à poncer - du papier de verre de grain gros et fin - une série d'épingles avec tête - 6 pincettes de bois - 1 pinceau.

Si quelques uns de ces outils devait vous manquer, vous pourrez les acquérir chez votre revendeur, sur la de base du catalogue d'outillage, contenu dans la boîte.

De uitrusting: Voor de bouw van het eerste stadium van bouw van dit model, de schaal, hebben wij enkele werktuigen nodig die wij u opsommen: Een kleine hamer - mes voor balsahout met zeer snijdende plaatjes - een reeks van kleine vijlen - de bankschroef voor lijstjes - een reeks schuurpapier ruw en fijn - een reeks spelden met hoofd - 6 tangetjes in hout - 1 penseel. Als enkele deze werktuigen u moesten gebrek hebben aan, zult u ze kunnen verkrijgen bij uw kleinhandelaar, op basis van de catalogus van werktuigen, catalogus geleverd in de doos.

Equipamiento: Para la construcción de la primera fase de este modelo, el casco, es necesario emplear algunas herramientas que pasamos a enumerar. Martillo pequeño - Cúter con las hojas muy afiladas - Varias limas - Ahusador de listones - Varios taponos de papel de lija - Papel de lija grueso y fino - Varios alfileres con cabeza - 6 pinzillas de madera - 1 pincel. Si le hace falta alguna de estas herramientas, podrá adquirirla en su tienda habitual, en base al catálogo de utensilios, que se encuentra dentro de la caja.

Carta vetrata - Sand-paper - Schleifpapier
Papier de verre - Schuurpapier
Brsni papir - Papel de lija

Art. 8011 grana - grain - Körnung
korrel - gradacija - grano 80
Art. 8012 grana - grain - Körnung
korrel - gradacija - grano 180



23x27 cm.

Art. 8297



Martello professionale - Hammer - Hammer
Marteau professionnel - Professionele Hamer
Martillo profesional



Levigatori a carta vetrata doppia faccia - Double face sanding stick
Schleifer mit 2-Schleifpapieren - Stick à poncer double face
Schurrblok voor 2-zydig schuurpapier - Pulidor de hoja de doble lija

Grana - Grain - Körnung - Korrel - Grano 80 e 220

Art. 8190 mm 20x80 Art. 8191 mm 30x100
Art. 8192 mm 40x120 Art. 8193 mm 50x140
Art. 8194 mm 60x160
Art. 8195 Serie 5 pezzi - Set of 5 pieces - Satz 5 stuck
Assortiment de 5 pièces - Serie 5 piezas

Rastremalistelli e supporto scafo - Strip clamp & hull holder
Leistenschneider und kielklemme
Etau pour listeau et fixation de quille
Klamp voor latten en kielhouder
Ahusador de listones y soporte del casco



Art. 8155

Art. 8160

Tornio elettrico per legno - Wood working lathe
Holz-DrehbanTour a bois
Electrische houtdraaibank
Torno eléctrico para madera



Art. 8263

Coltello leggero in alluminio - Light alu knife
Messer Leichte Ausführung
mit Aluminiumgriff
Couteau léger
en aluminium
Licht mes
in aluminium
Cuchillo ligero de aluminio

Art. 8200 5P.

Lama inclinata
Ersatzklingen
Long angled blade
Lame inclinée
Schuin blad
Cuchilla inclinada



Art. 8300

Serie limette con impugnatura - Set of files with handle
Nadelfeilen-Set - Set limes avec manche
Set van vijlen met heft - Varias limas con empuñadura

Spilli da lavoro
Plastic-head pins
Stecknadeln
Epingles à tête en
plastique
Steeknaalden
Alfileres de trabajo



Art. 2476

Art. 8178

Mollette di serraggio
Pegs - Pincas - Klammern
Knijpers - Pinzas de sujeción



Art. 1556

Pennello - Brush - Pinsel - Piceau - Borstel - Pincel

CUTTY SARK "Le Piccole"



Tavola compensato - Plywood board - Sperrholzplatte - Planche contreplaqué - Plaat triplex - Tabla chapa



Tavola compensato - Plywood board - Sperrholzplatte - Planche contreplaqué - Plaat triplex - Tabla chapa

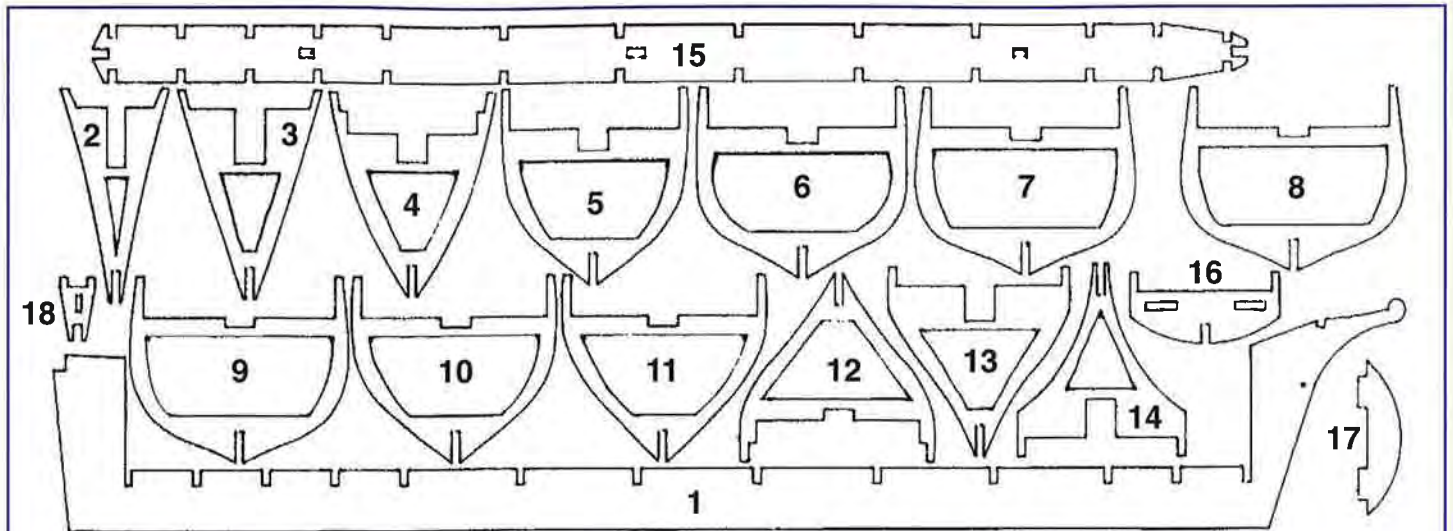

Tavola compensato - Plywood board - Sperrholzplatte - Planche contreplaqué - Plaat triplex - Tabla chapa

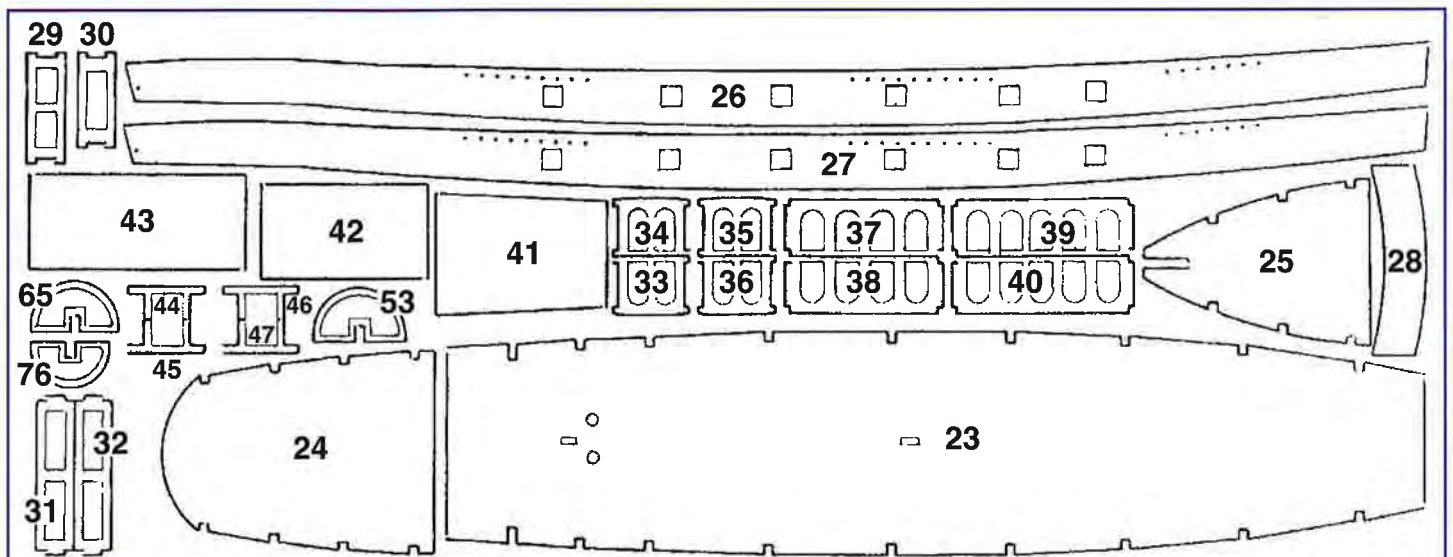

1
 Numerare le parti - Number the parts
 Die Teilenummern sind im Bauplan wiedergegeben
 Numéroter les pièces - Nummeren van de stukken
 Numerar las piezas una a una

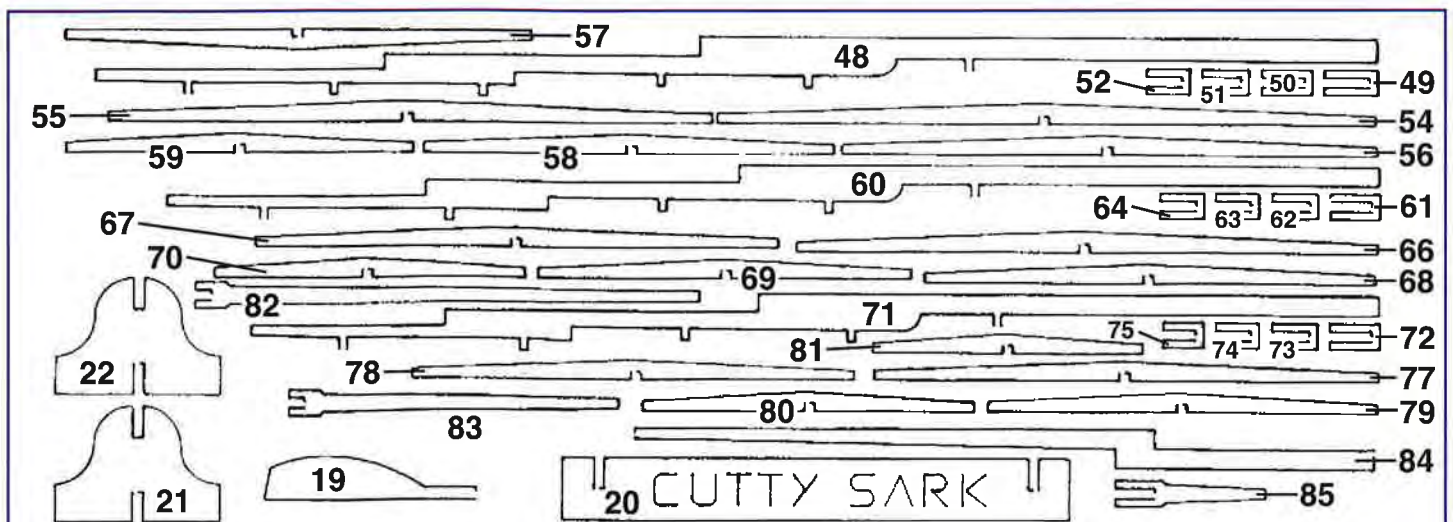
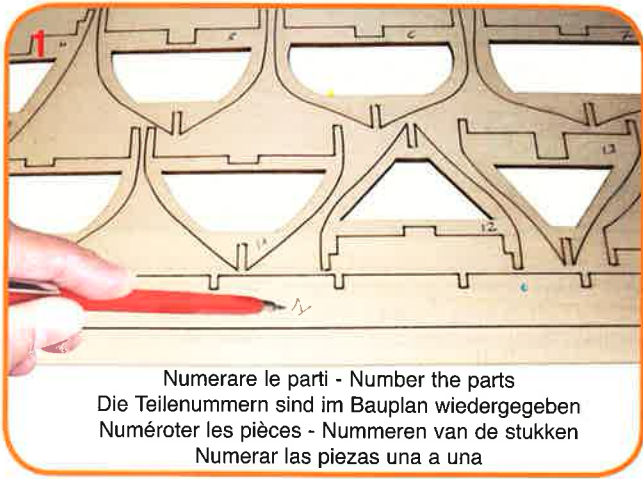
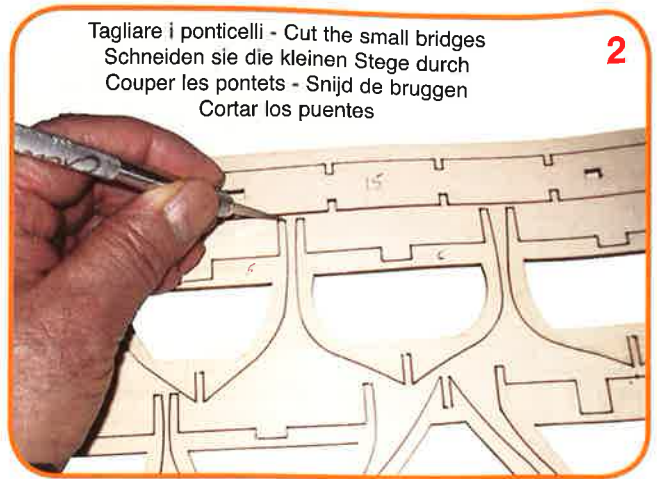

2
 Tagliare i ponticelli - Cut the small bridges
 Schneiden sie die kleinen Stege durch
 Couper les pontets - Snijd de bruggen
 Cortar los puentes

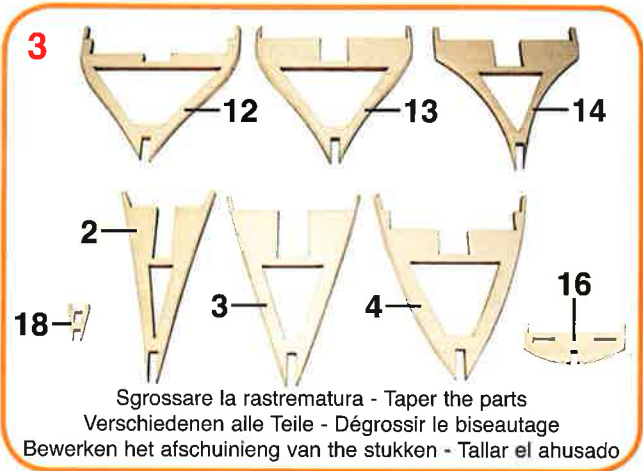

3
 Sgrossare la rastrematura - Taper the parts
 Verschiedenen alle Teile - Dégrossir le biseautage
 Bewerken het afschuinieng van the stukken - Tallar el ahusado

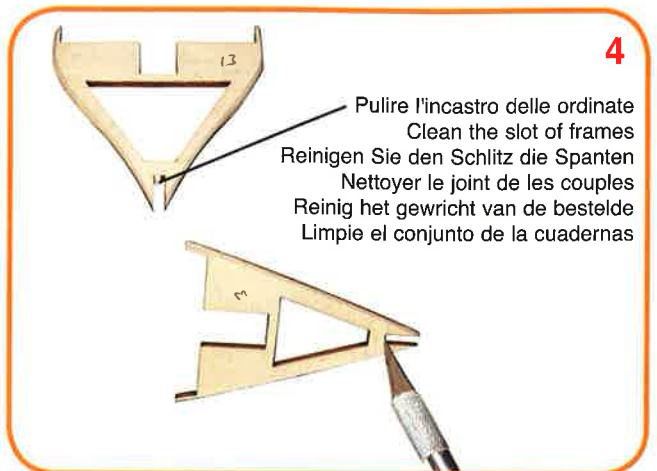

4
 Pulire l'incastro delle ordinate
 Clean the slot of frames
 Reinigen Sie den Schlitz die Spanten
 Nettoyer le joint de les couples
 Reinig het gewricht van de bestelde
 Limpie el conjunto de la cuadernas

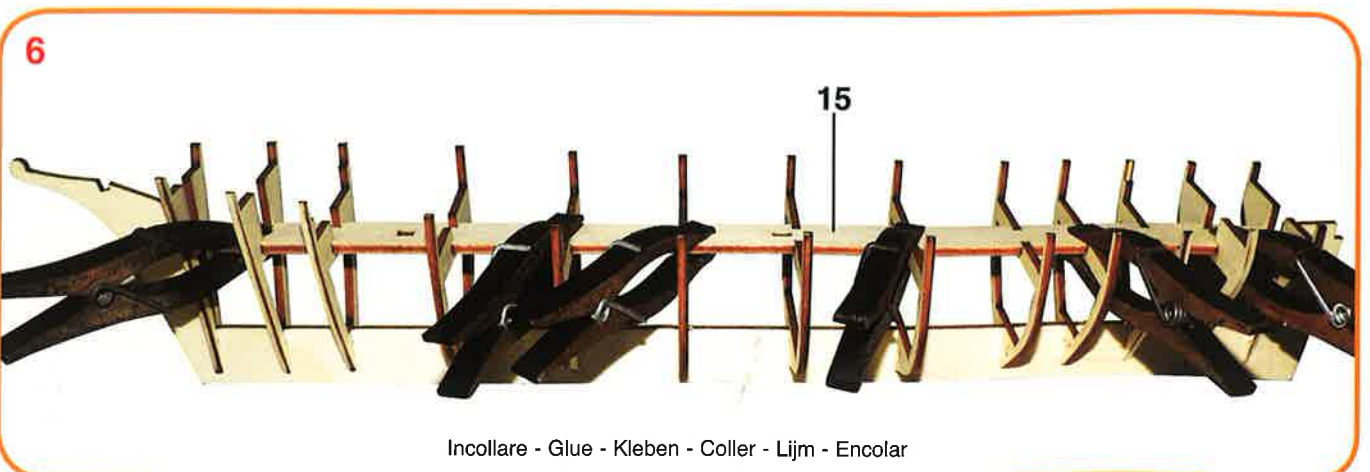
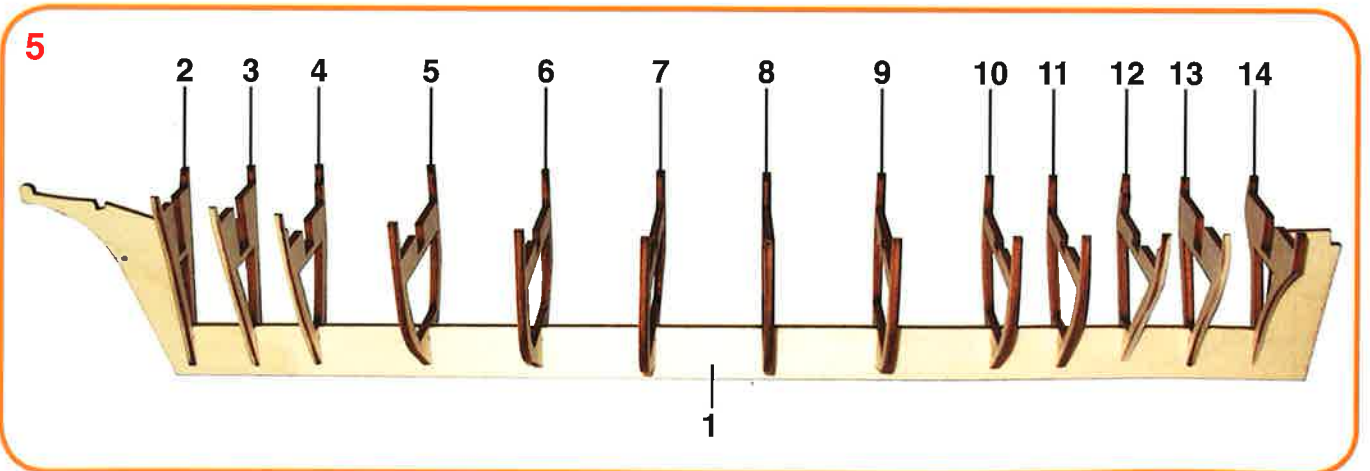

6
 Incollare - Glue - Kleben - Coller - Lijm - Encolar

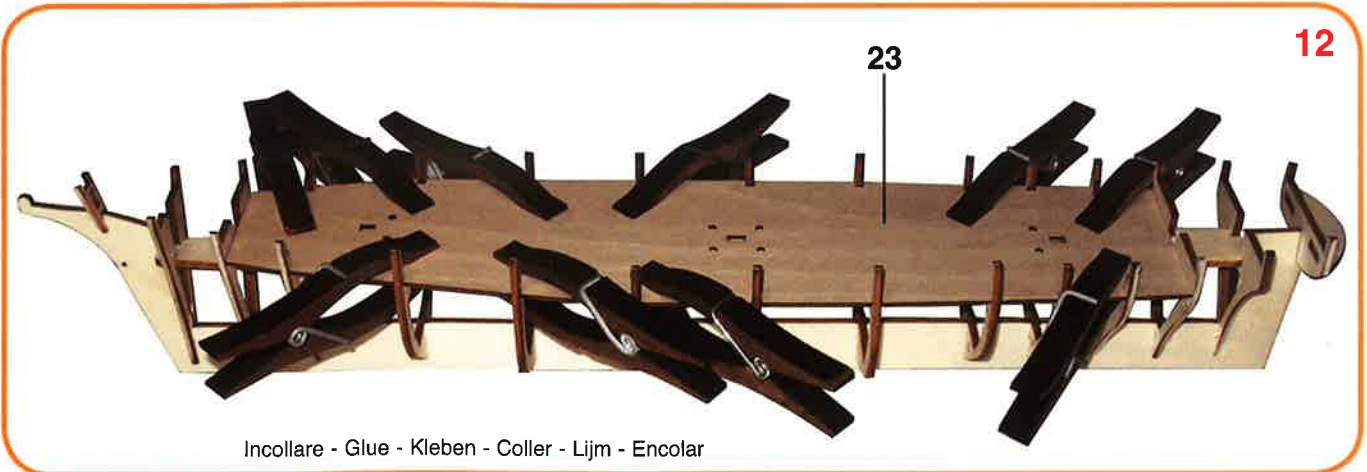
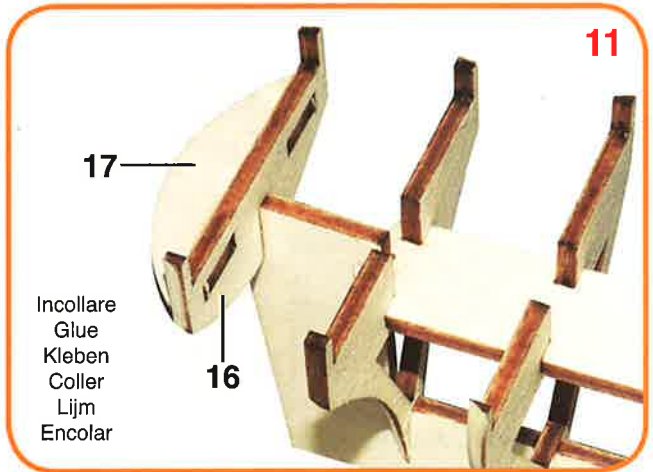
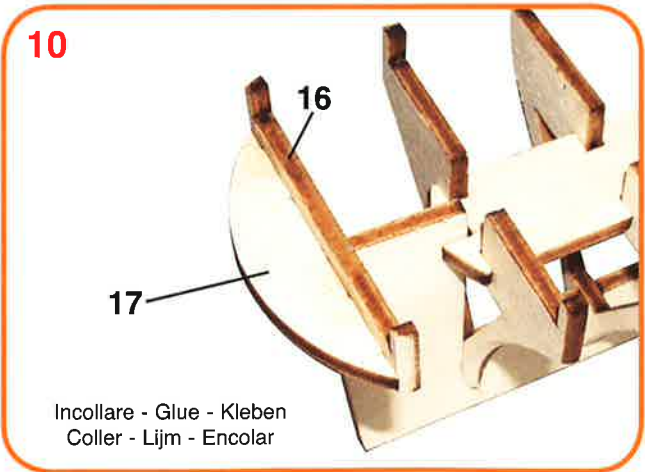
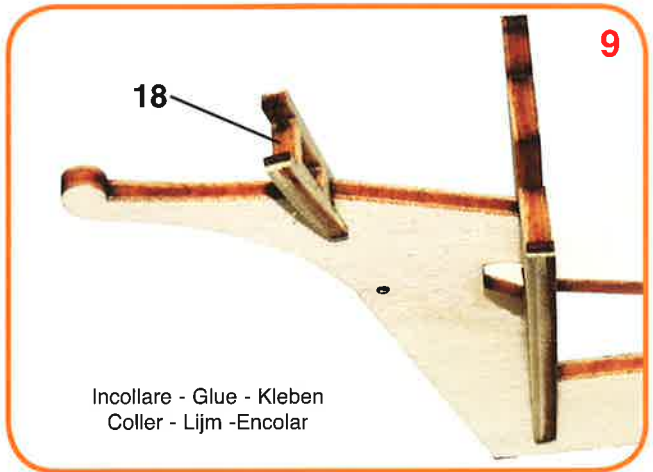
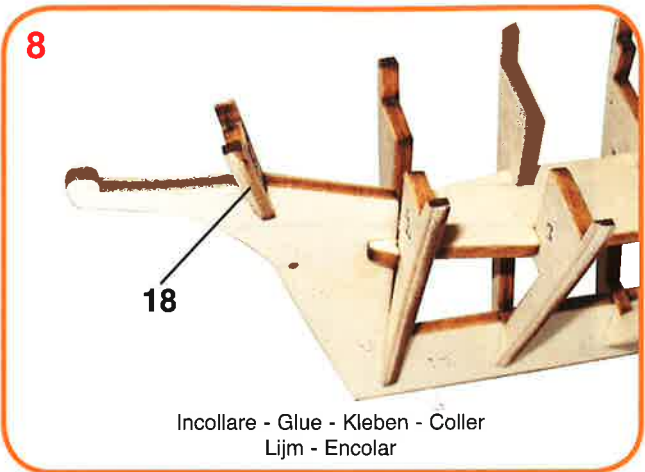
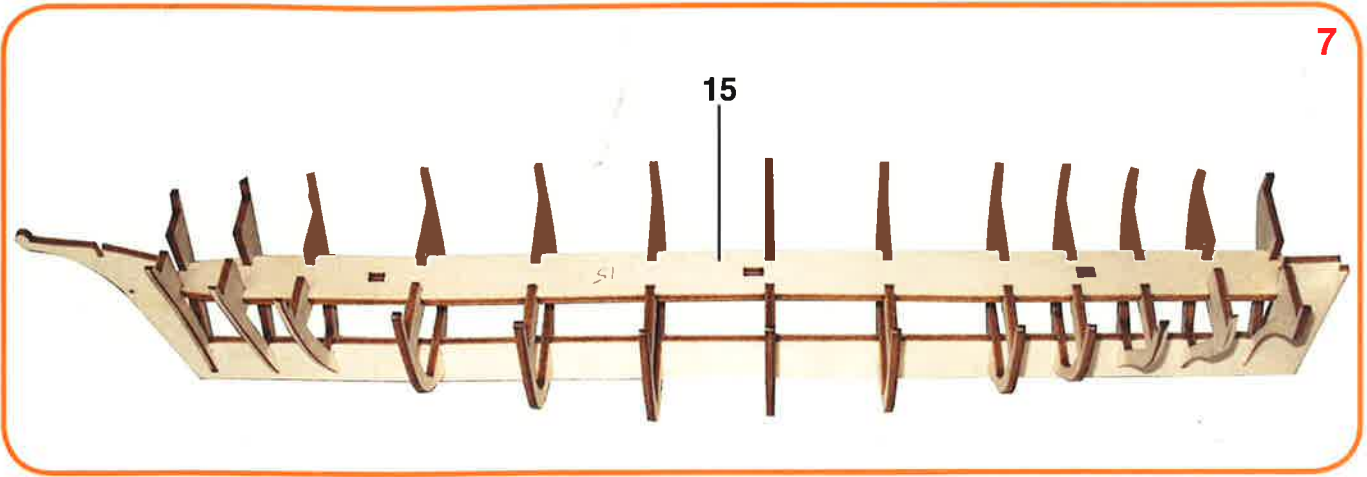

13

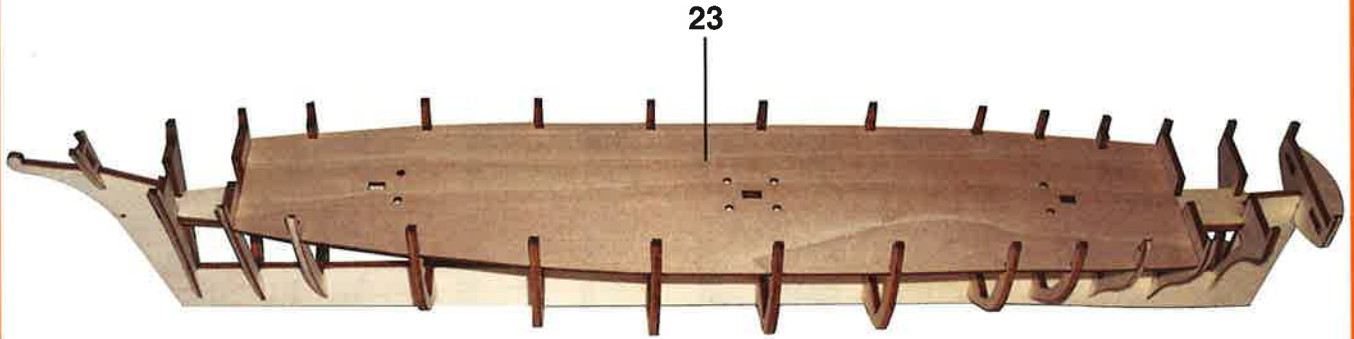

14

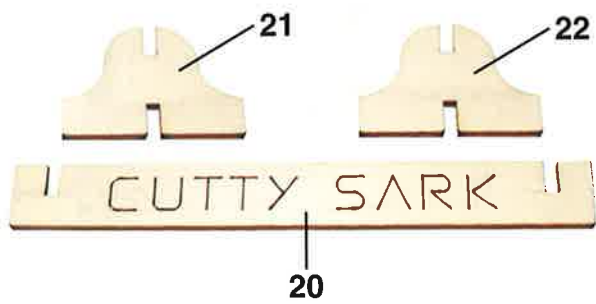

Incollare - Glue - Kleben - Coller - Lijm - Encolar

15



16

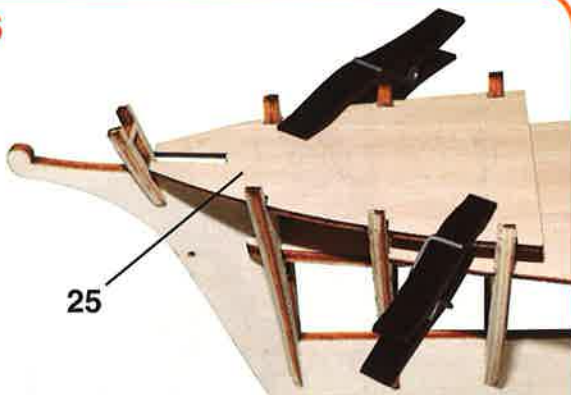

Incollare - Glue - Kleben - Coller - Lijm - Encolar

17



18

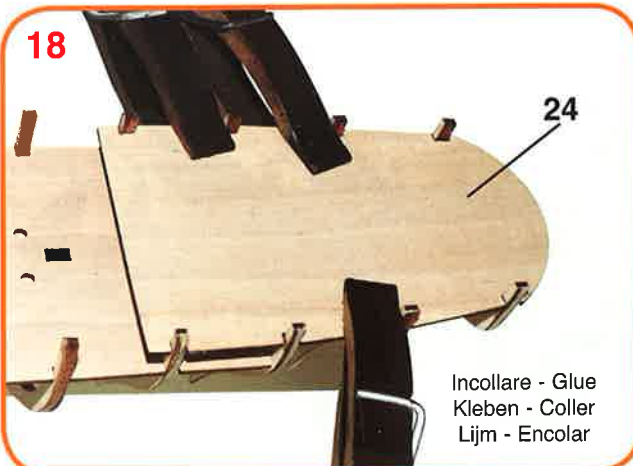

Incollare - Glue
Kleben - Coller
Lijm - Encolar

19

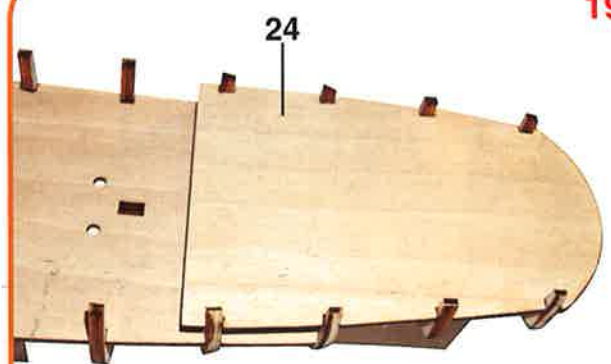

20



Piegare il listello con la pinza sagomatrice
Bend strip with the strip bender
Leiste mit einer Zange zum Vorformen biegen
Plier la latte avec la pince à cintrer
Vouwen de lijstjes met de buigtang
Plegar el listón con la pinza perfiladora
Art. 8151

21

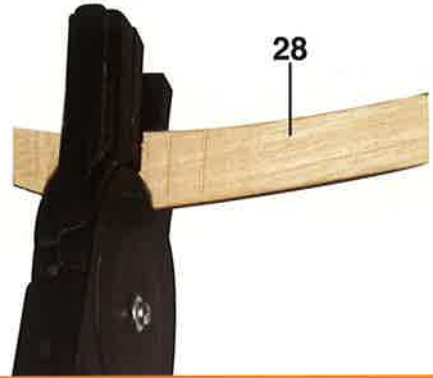

28

22



28

Incollare - Glue
Kleben - Coller
Lijm - Encolar

23

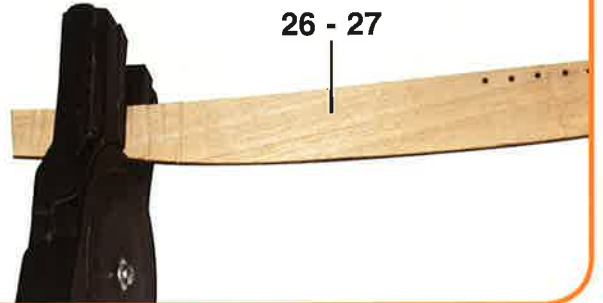

26 - 27

Incollare - Glue - Kleben - Coller - Lijm - Encolar

24

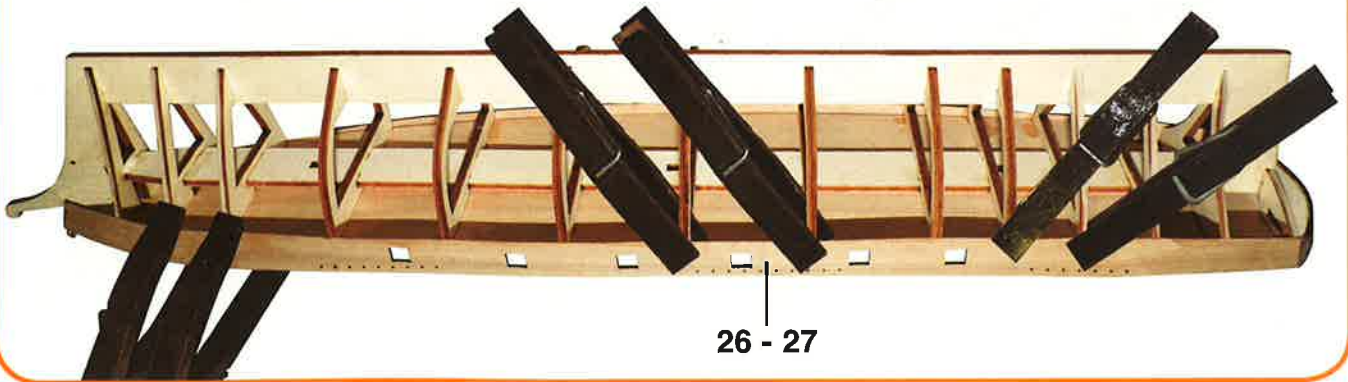

26 - 27

25



27

26

26

Incollare - Glue - Kleben - Coller - Lijm - Encolar



Listelli tiglio - Lime wood strips - Lindenholzleisten
 Listeaux en tilleul - Strips in lindehout - Listones de cal
 1x3x460 mm

27

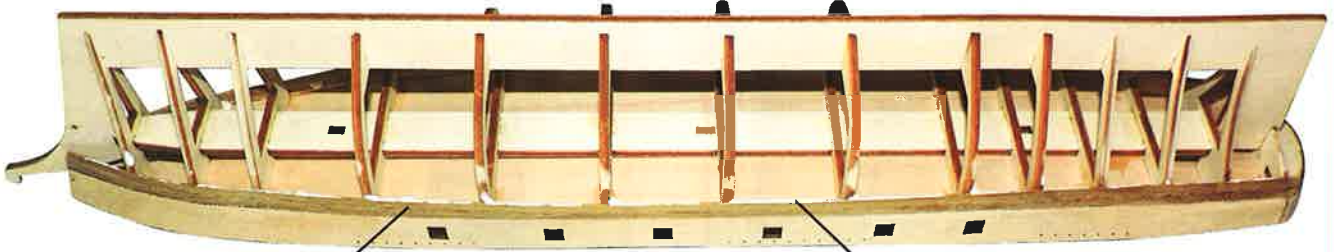

Listelli tiglio - Lime wood strips - Lindenholzleisten
 Listeaux en tilleul - Strips in lindehout - Listones de cal
 1x3x460 mm

Incollare - Glue - Kleben
 Coller - Lijm - Encolar

28

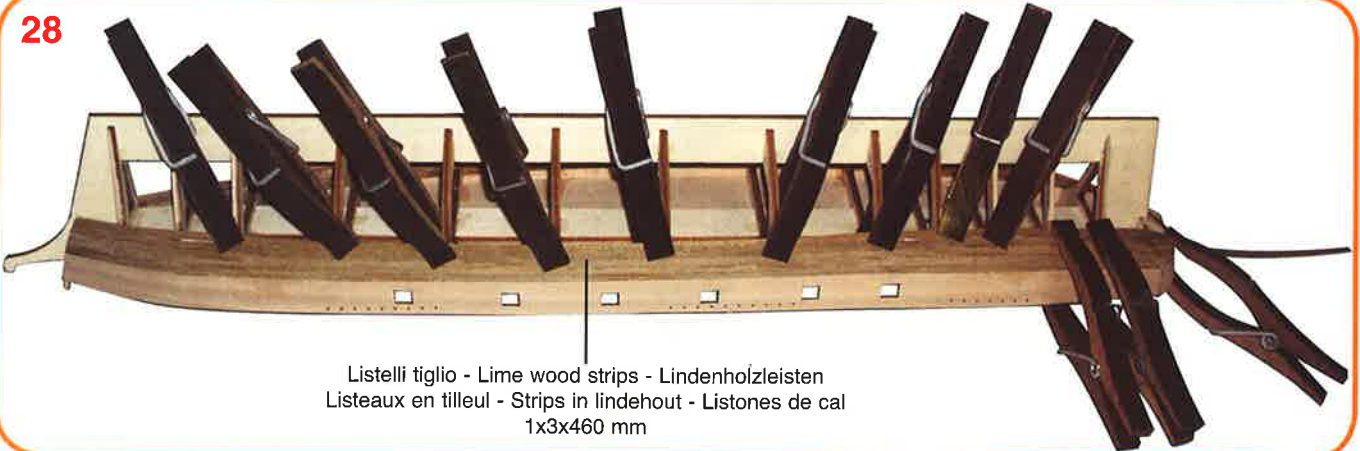

Listelli tiglio - Lime wood strips - Lindenholzleisten
 Listeaux en tilleul - Strips in lindehout - Listones de cal
 1x3x460 mm

29



Listelli tiglio - Lime wood strips - Lindenholzleisten - Listeaux en tilleul - Strips in lindehout - Listones de cal
 1x3x460 mm

30



Listelli tiglio - Lime wood strips - Lindenholzleisten - Listeaux en tilleul - Strips in lindehout - Listones de cal
1x3x460 mm

31



Listelli tiglio - Lime wood strips - Lindenholzleisten - Listeaux en tilleul - Strips in lindehout - Listones de cal
1x3x460 mm

32



Listelli tiglio - Lime wood strips - Lindenholzleisten
Listeaux en tilleul - Strips in lindehout - Listones de cal
1x3x460 mm

33



Listelli tiglio - Lime wood strips - Lindenholzleisten - Listeaux en tilleul - Strips in lindehout - Listones de cal
1x3x460 mm

34



Stuccare - Putty - Verspachteln - Stuquer - Vullen - Estucar
 Consigliato - Recommended - Empfohlen - Recommandé - Geadviseerd - Recomendado
 Art. 1022

Carteggiare - Sand - Schleifen - Poncer - Schuur - Lijar

35



Proteggere con 3 mani di turapori Art. 1020 - Coat 3 times with sanding sealer Art. 1020 - Mantel 3mal mit Porenfüller Art. 1020
 Protéger avec 3 mains de bouche-pores Art. 1020 - Bedekt 3 keer met het primer & porienvuller Art. 1020
 Proteger con 3 manos de barniz de fondo Art. 1020

36

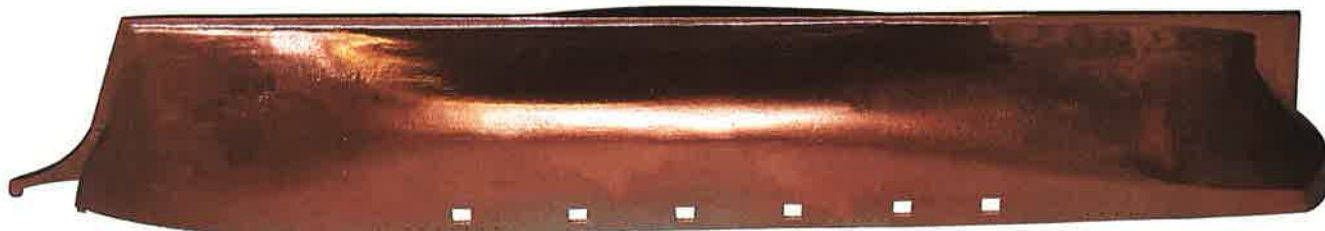

Verniciare color rame - Paint copper - Kupferfarben lackieren - Vernir en couleur cuivre
 Vernissen en in koper kleur schilderen - Pintar color el cobre

Sistema pratico per tracciare l'esatta linea di galleggiamento,
 l'attrezzo è ricavato da due ritagli di compensato.
 Easy system to trace the exact waterline,
 the tool is made with two scraps of plywood.
 Praktisches System, um die genaue Wasserlinie
 verfolgen, das Tool basiert auf zwei Fetzen
 von Sperrholz Basis.
 Un système très pratique pour tracer la ligne
 de flottaison exacte, l'outil est basé sur
 deux morceaux de contreplaqué.
 Praktisch systeem om de exacte waterlijn op te
 sporen, de tool is gebaseerd op twee stukjes triplex.
 Práctico sistema para trazar la línea de flotación
 exacta, la herramienta se basa en dos
 trozos de madera.

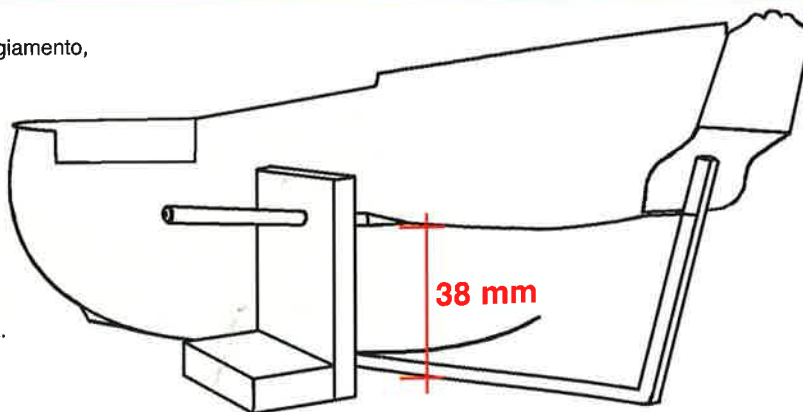

37

Verniciare nero - Paint black - Schwarz lackieren - Vernir noir
Vernissen zwart - Pintar negro



38

Verniciare bianco - Paint white - Weiß lackieren - Vernir blanc
Vernissen wit - Pintar blanco



39

Listello noce - Walnut strip - Nußbaumleiste
Listeau en noyer - Strip notelaar
Listone de nogal
1x2x460 mm

Verniciare bianco
Paint white - Weiß lackieren
Vernir blanc - Vernissen wit - Pintar blanco

Listello noce - Walnut strip
Nußbaumleiste - Listeau en noyer
Strip notelaar - Listone de nogal
1x2x460 mm

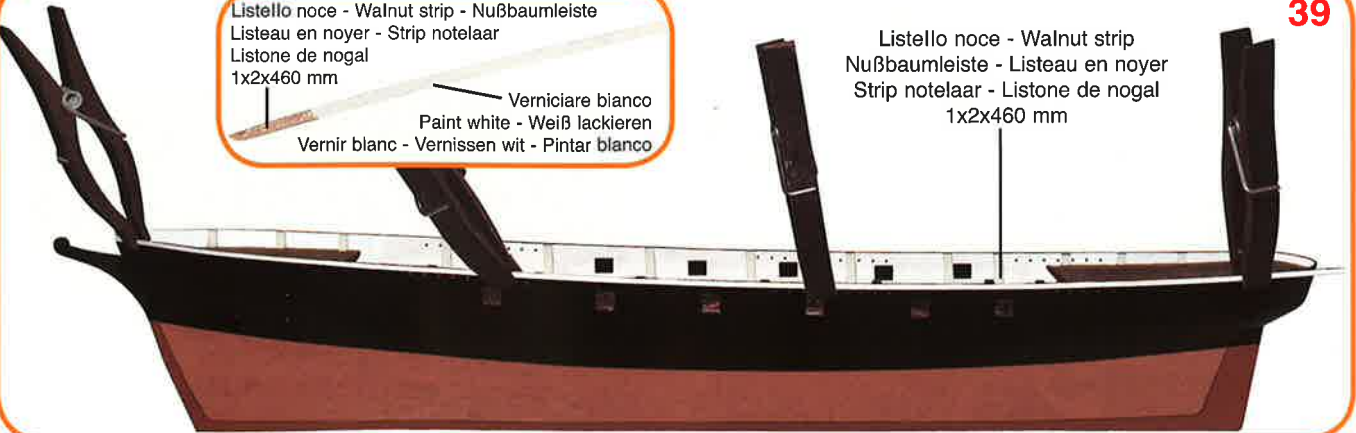

40

Listello noce - Walnut strip - Nußbaumleiste - Listeau en noyer
Strip notelaar - Listone de nogal
1x2x460 mm

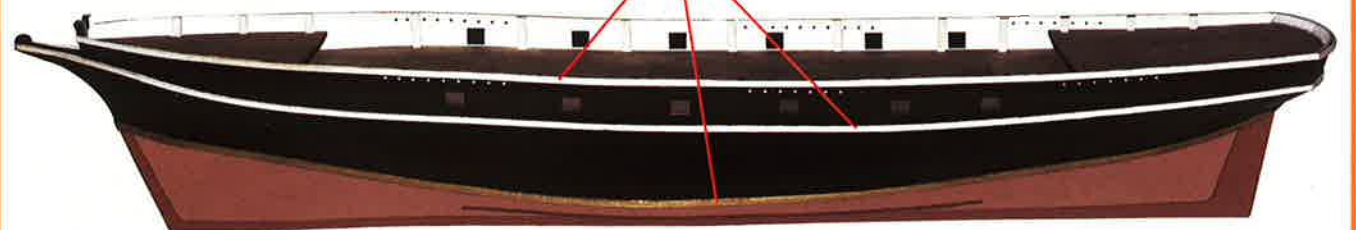

41

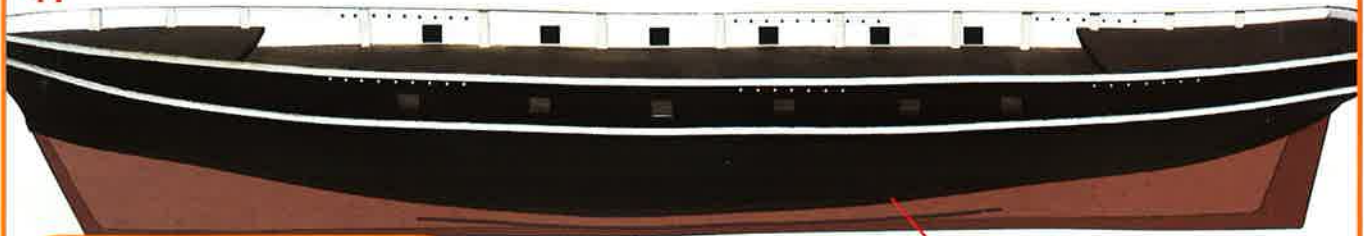

Listello noce - Walnut strip - Nußbaumleiste
 Listeau en noyer - Strip notelaar
 Listone de nogal
 1x2x460 mm

Verniciare nero
 Paint black
 Schwarz lackieren - Vernir noir
 Vernissen zwart - Pintar negro

Listello noce - Walnut strip - Nußbaumleiste - Listeau en noyer
 Strip notelaar - Listone de nogal
 1x2x460 mm

42



Listello noce
 Walnut strip
 Nußbaumleiste
 Listeau en noyer
 Strip notelaar
 Listone de nogal
 1x2x460 mm

43

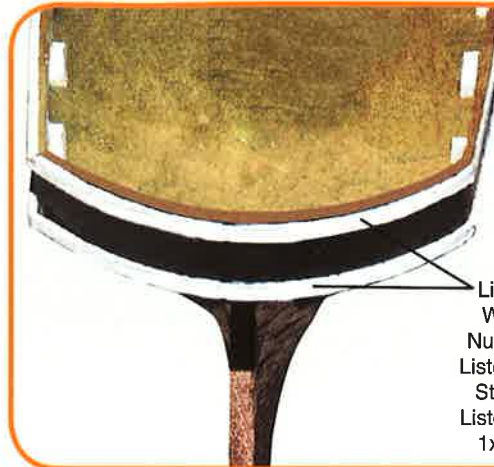

Listello noce
 Walnut strip
 Nußbaumleiste
 Listeau en noyer
 Strip notelaar
 Listone de nogal
 1x2x460 mm

OPTIONAL

Art. 32902

Vi illustriamo come applicare le piastre di rame in legno laserinciso e verniciato a spruzzo. Le piastre sono un optional non contenuto nella scatola, ma acquistabile separatamente.

We show how to place the coppering tiles, made with laser engraved wood. The coppering material is not supplied with the kit and is optional and can be purchased separately.

Teil des Rumpfs. Auf diesen Fotos sehen Sie, wie die mit Laser eingeschnittenen, mit Spray lackierten, hölzernen Kupferplättchen befestigt werden. Diese Platten sind Extrazubehör, der nicht im Bausatz vorhanden ist, sondern separat erworben werden kann.

Le cuivre des œuvres vives du bateau (la partie immergée de la coque). Sur ces photos, nous vous illustrons comment appliquer les plaques de cuivre en bois gravées au laser et vernies avec un spray. Les plaques sont une option non contenue dans la boîte, mais achetable séparément.

Op deze foto's, verduidelijken wij u hoe de platen van koper in hout toepassen gegraveerd aan de laser en vernist met een spray. De platen zijn niet inbegrepen in de bouwdoos, maar koopbaar afzonderlijk.

En esta foto ilustramos cómo aplicar las placas de cobre en madera grabada con el láser y pulverizada con barniz. Las placas son opcionales y no están incluidas en el contenido de la caja, sino que se compran por separado.

A



Tavola laser-incisa - Laser engraved sheet
 Laser eingeschnitten - Planche laser-gravée
 Laser ingesneden plank - Tabla laser grabó

B

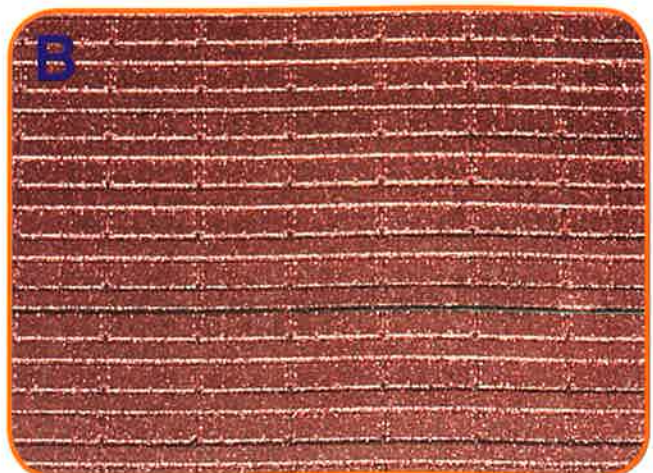

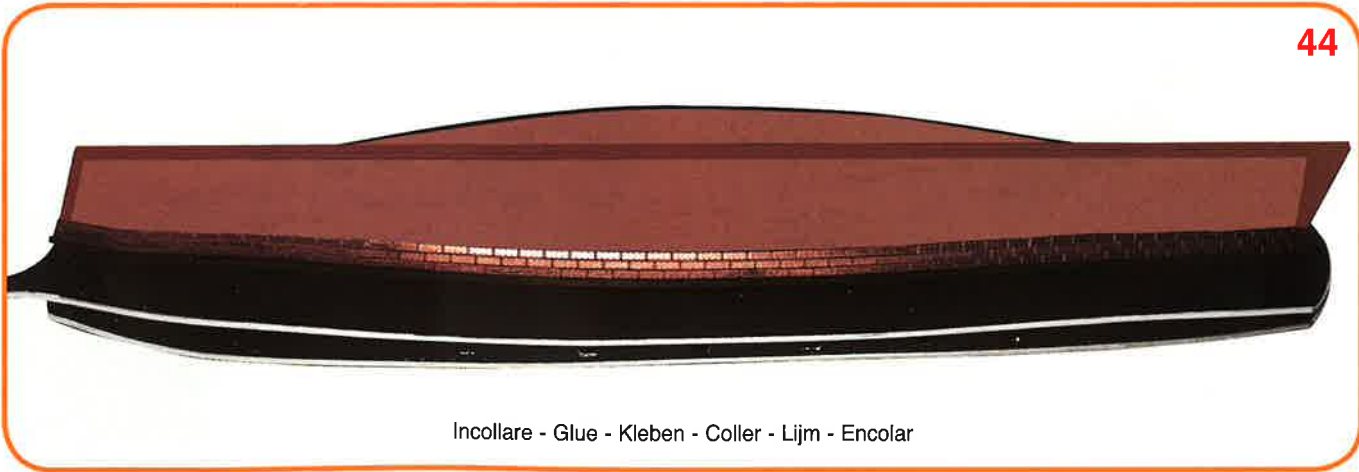
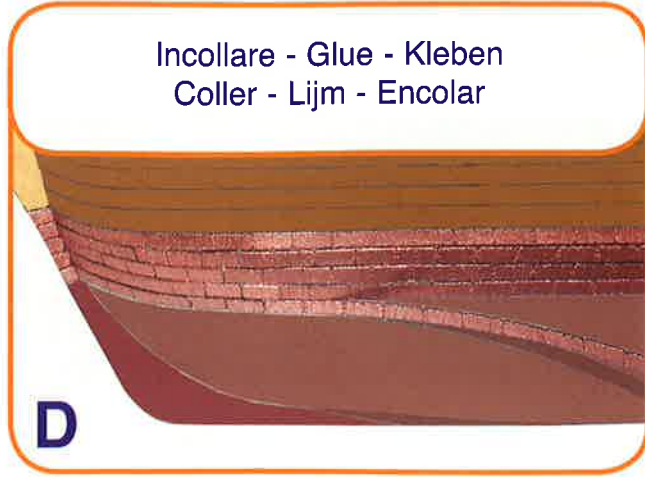
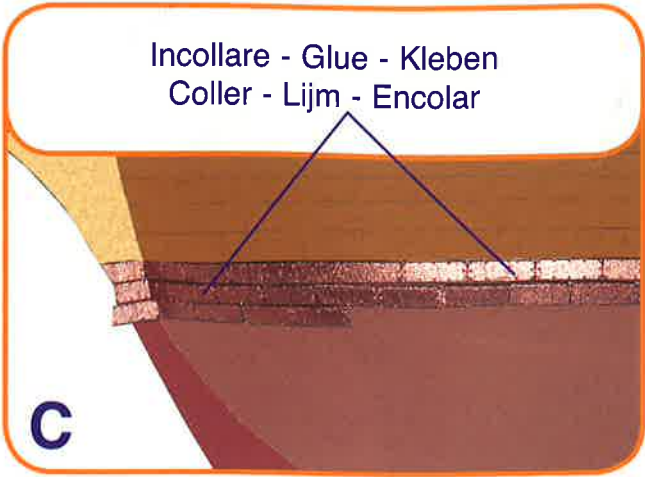

46

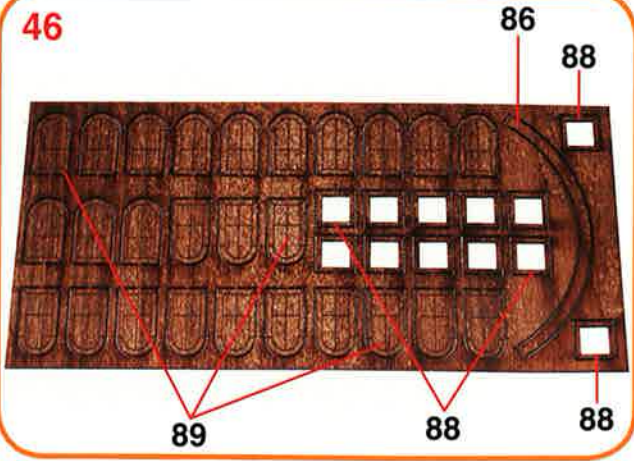

47



Incollare
Glue
Kleben
Coller
Lijm
Encolar

48



Listello noce - Walnut strip - Nußbaumleiste - Listeau en noyer
Strip notelaar - Listone de nogal
1x3x460 mm

49

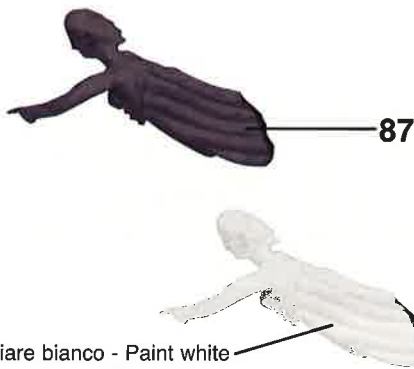

Verniciare bianco - Paint white
Weiß lackieren - Vernir blanc
Vernissen wit - Pintar blanco

50



Incollare - Glue
Kleben - Coller
Lijm - Encolar

51

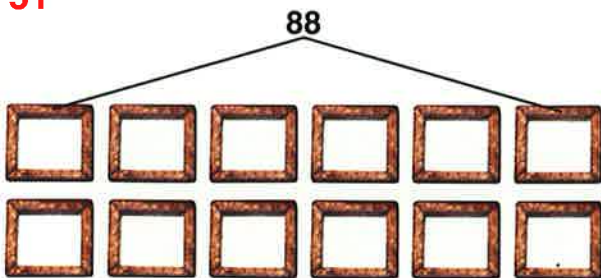

52

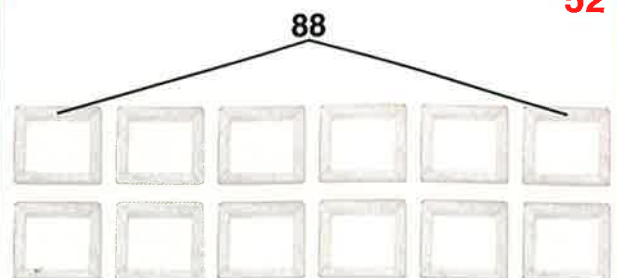

Verniciare bianco - Paint white - Weiß lackieren - Vernir blanc
Vernissen wit - Pintar blanco

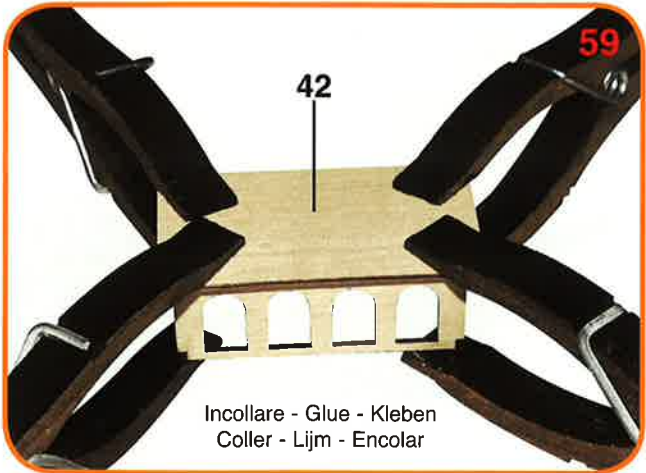
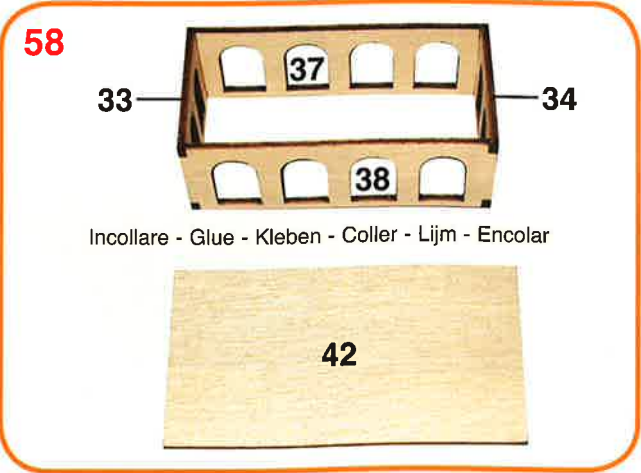
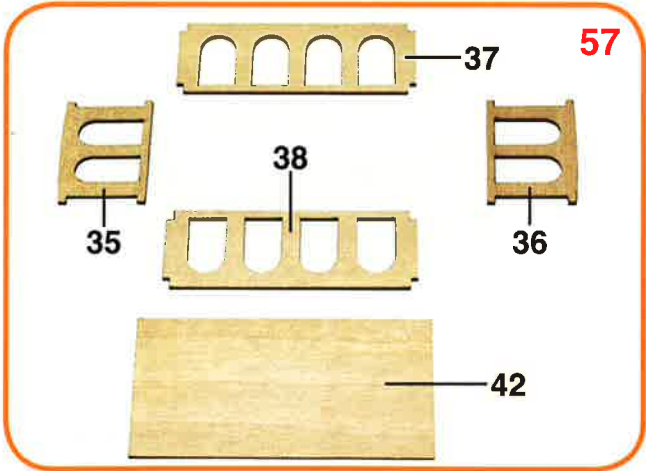
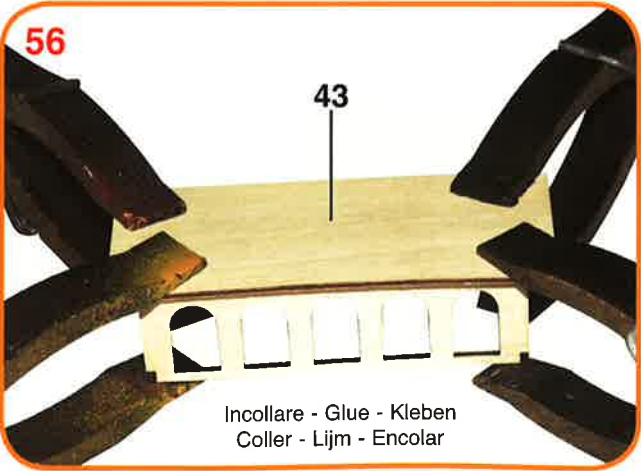
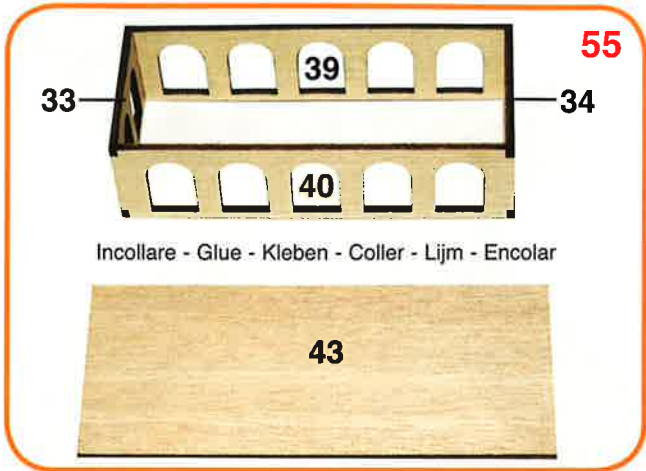
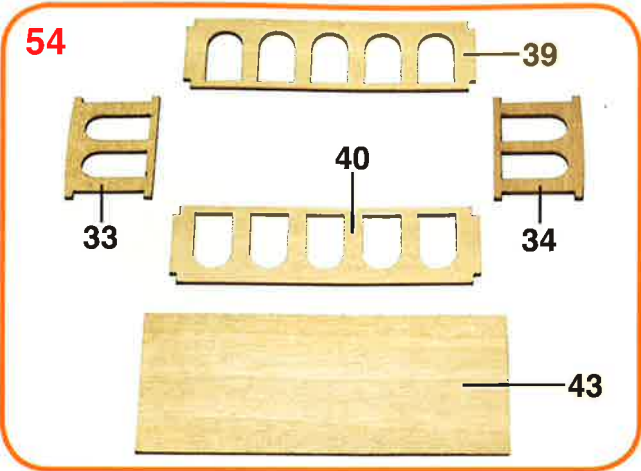
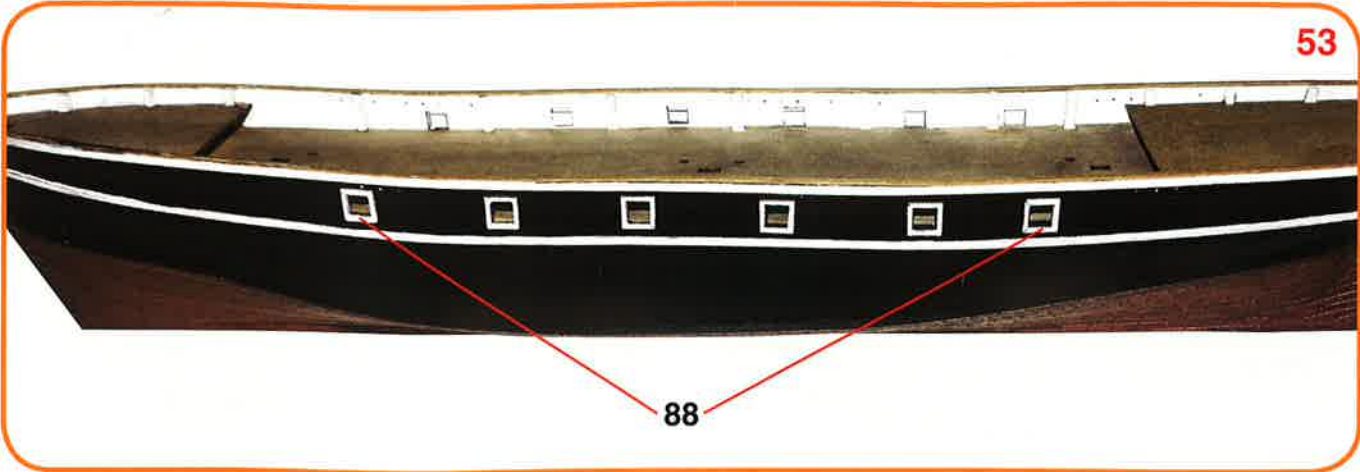

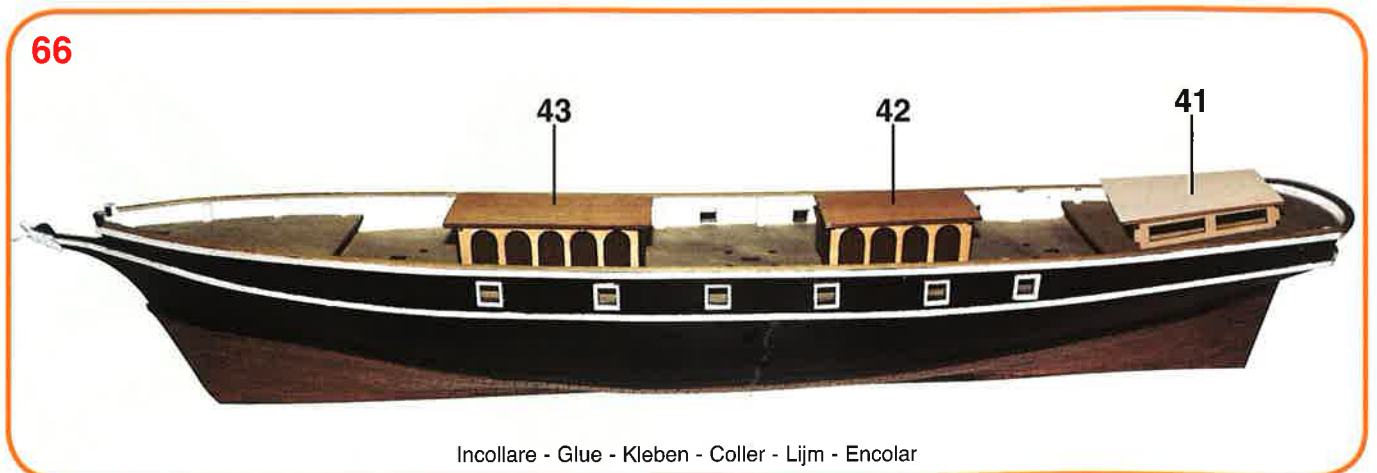
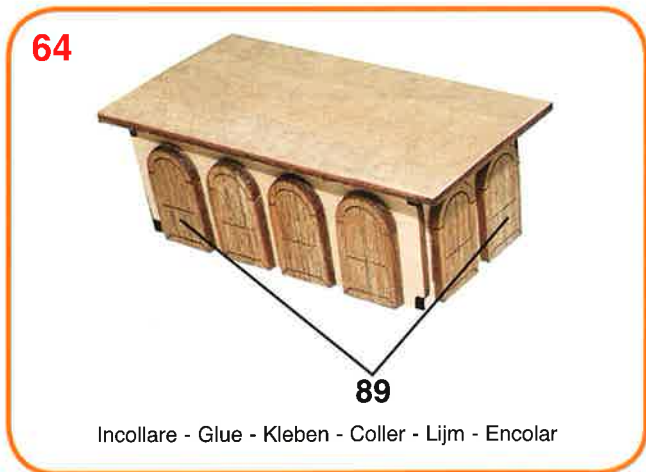
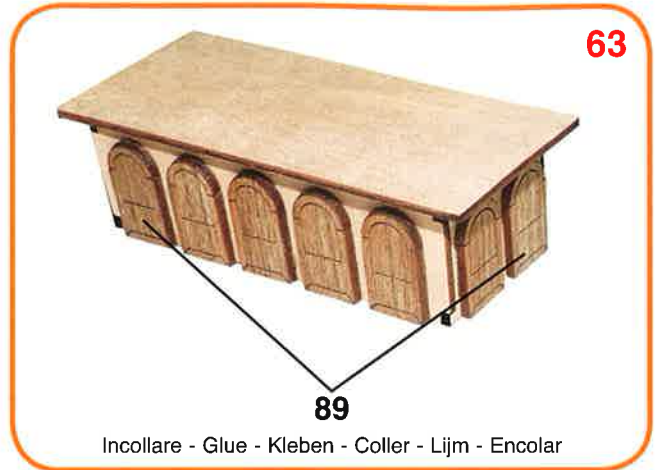
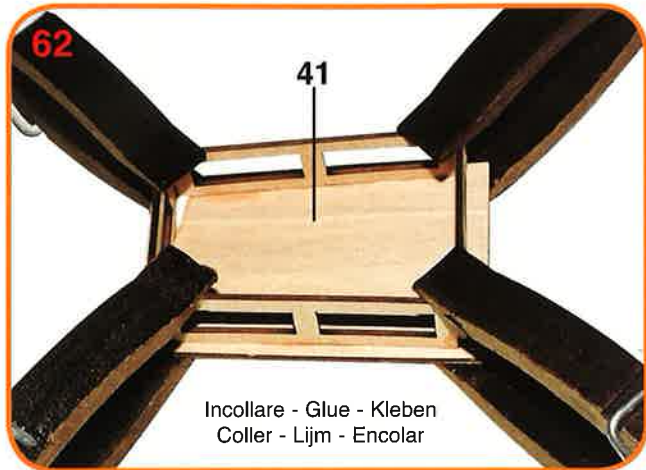
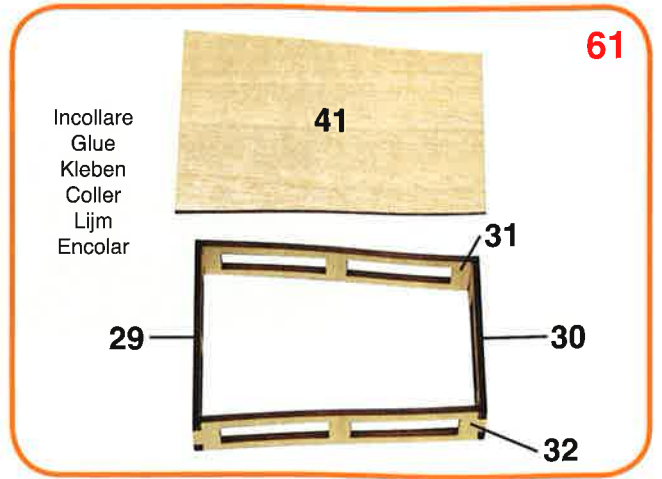
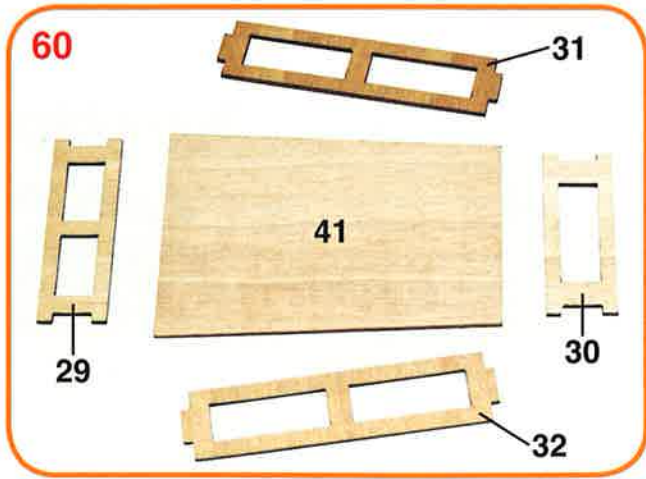

67

Incollare - Glue - Kleben
Coller - Lijm - Encolar



68

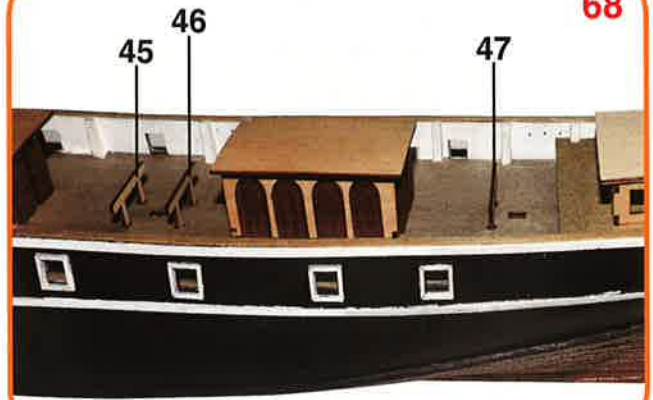

Incollare - Glue - Kleben - Coller - Lijm - Encolar

69

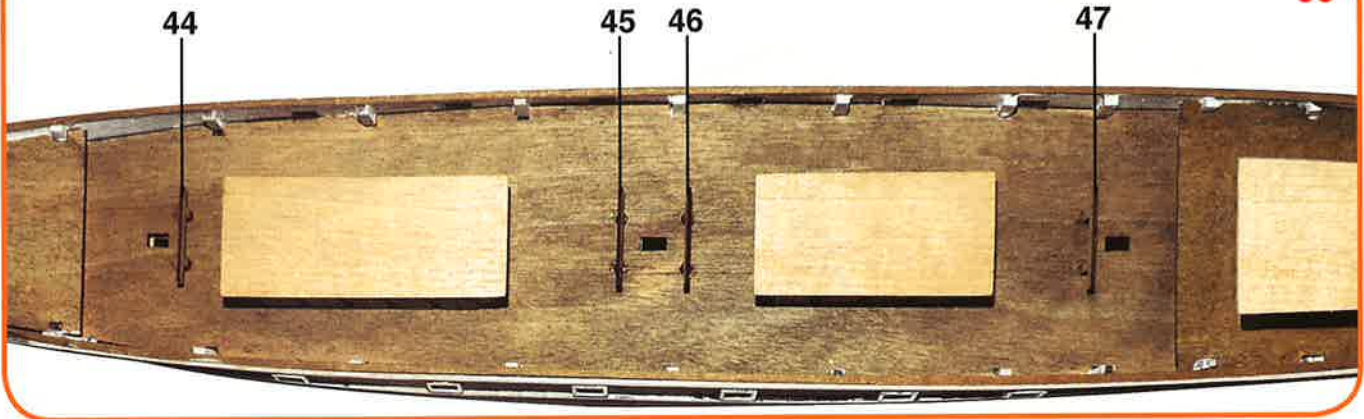

70



Verniciare nero - Paint black - Schwarz lackieren - Vernir noir
Vernissen zwart - Pintar negro

71

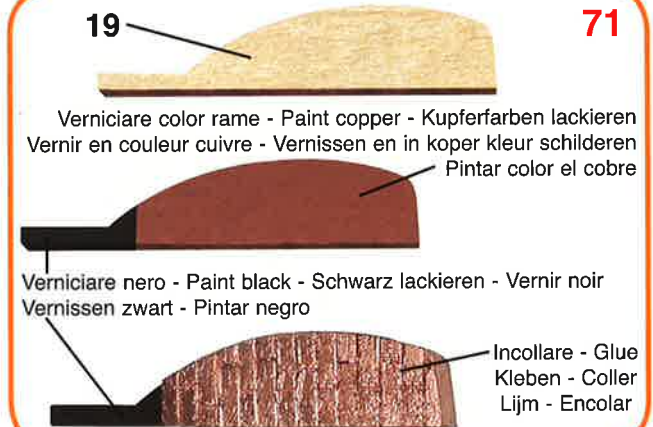

Verniciare color rame - Paint copper - Kupferfarben lackieren
Vernir en couleur cuivre - Vernissen en in koper kleur schilderen
Pintar color el cobre
Verniciare nero - Paint black - Schwarz lackieren - Vernir noir
Vernissen zwart - Pintar negro

Incollare - Glue
Kleben - Coller
Lijm - Encolar

72

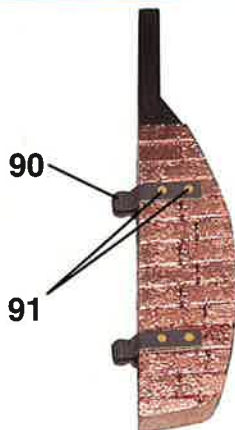

73

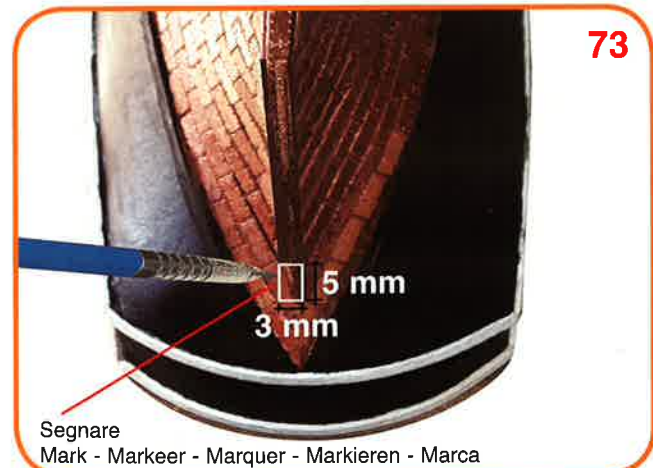

Segnare
Mark - Markeer - Marquer - Markieren - Marca

74

Sagomare
To mould
Formen
Moulerer
Modeln
Perfilar

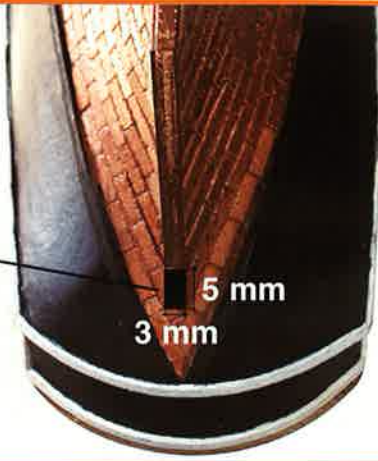

75



76

Incollare - Glue
Kleben - Coller
Lijm - Encolar

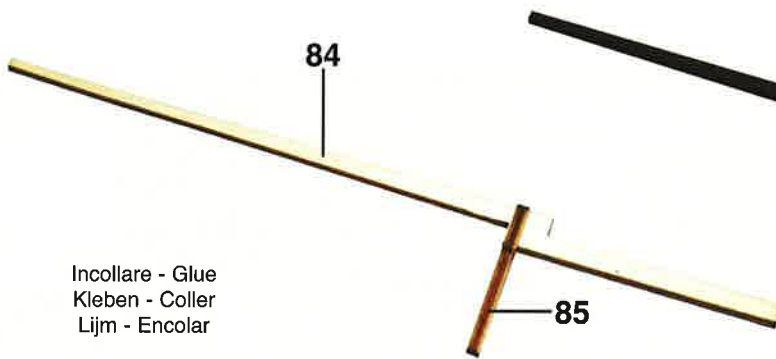

Verniciare nero - Paint black
Schwarz lackieren - Vernir noir
Vernissen zwart - Pintar negro



77

Incollare
Glue
Kleben
Coller
Lijm
Encolar

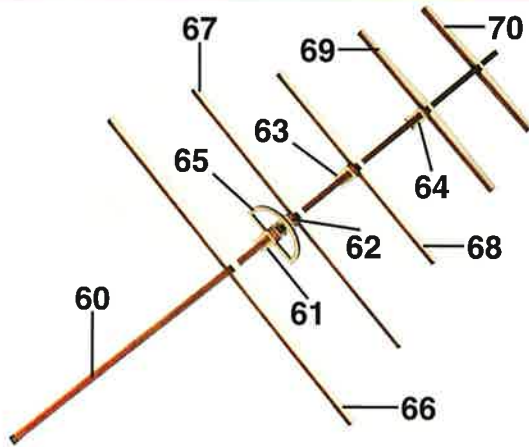

Verniciare nero
Paint black
Schwarz lackiere
Vernir noir
Vernissen zwart
Pintar negro

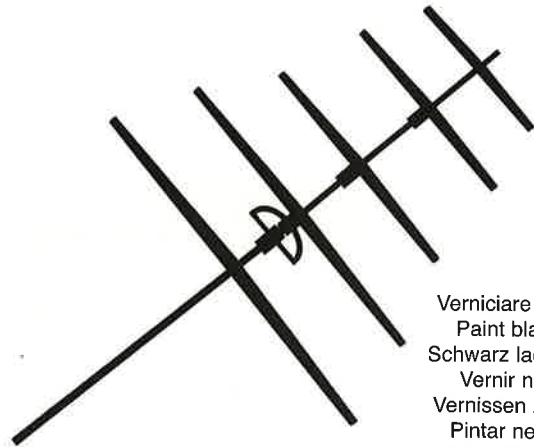

78

Incollare
Glue
Kleben
Coller
Lijm
Encolar

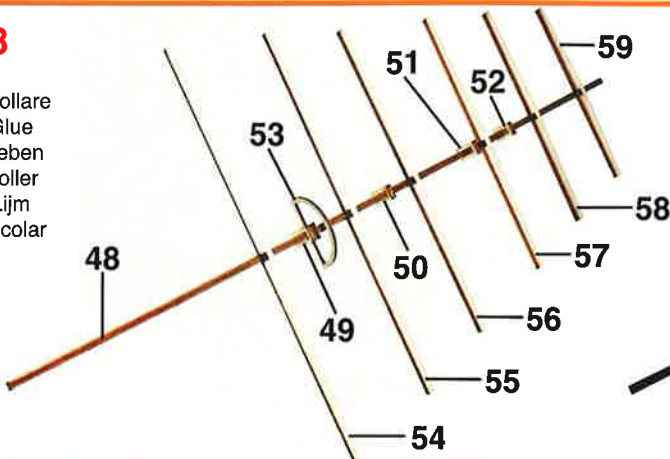

Verniciare nero
Paint black
Schwarz lackiere
Vernir noir
Vernissen zwart
Pintar negro

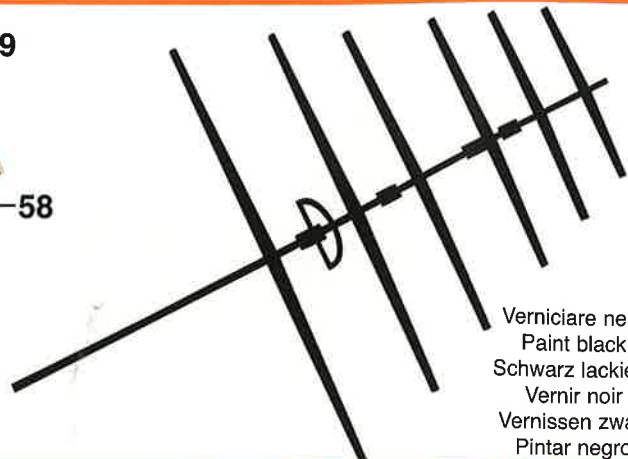

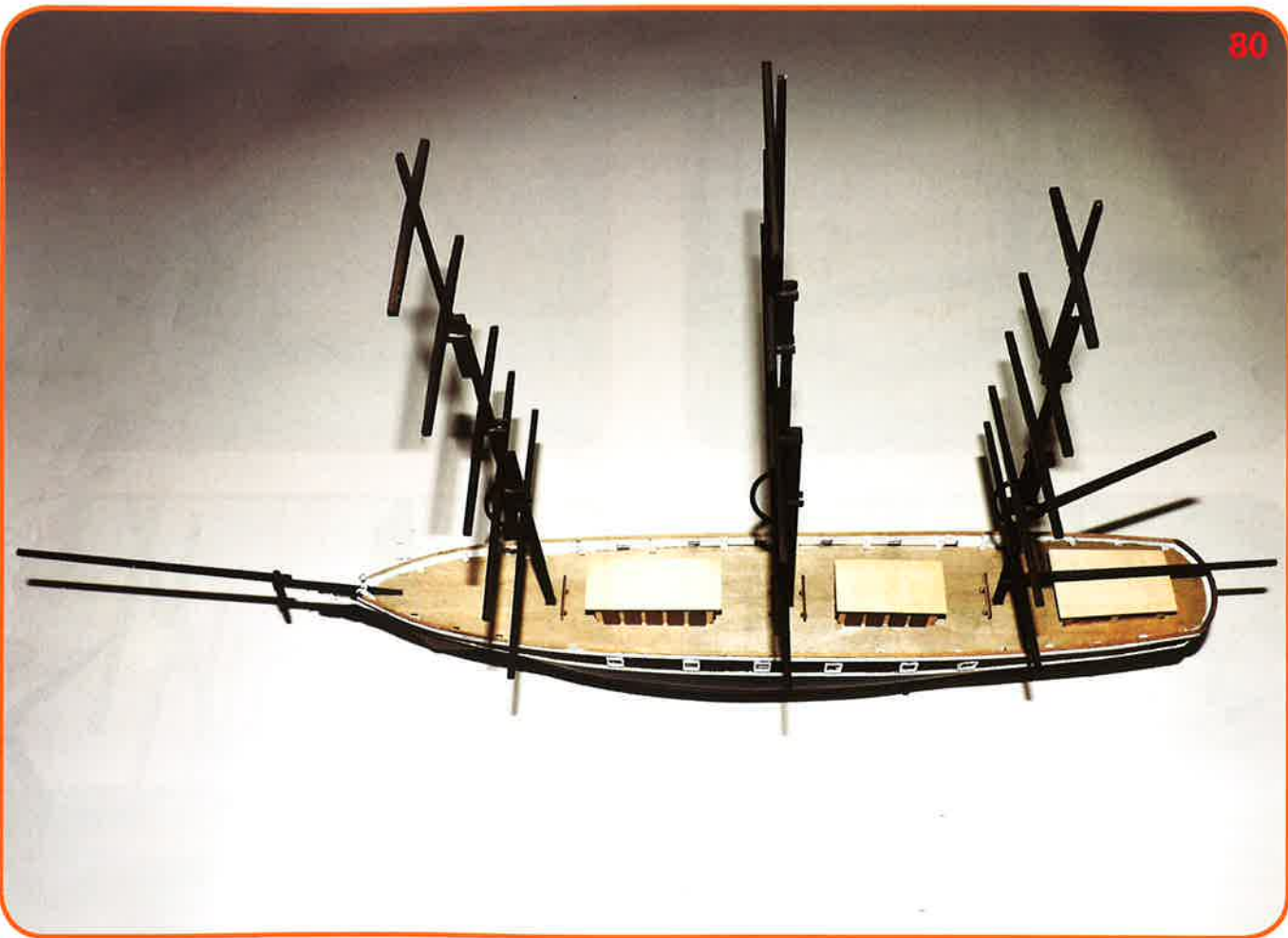
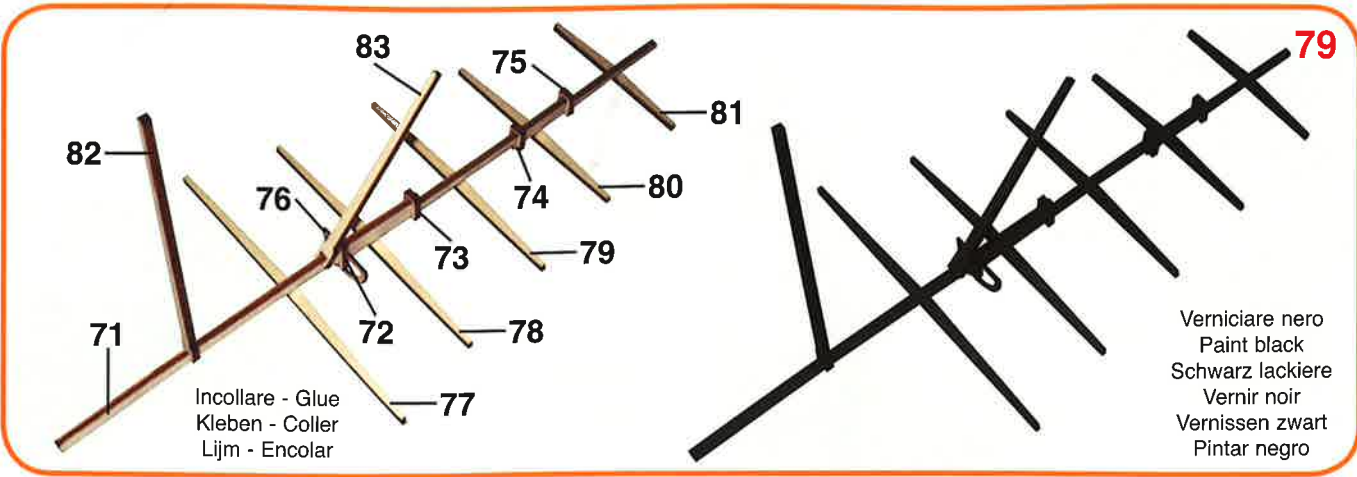



83



84



85



86



87



88



89



90

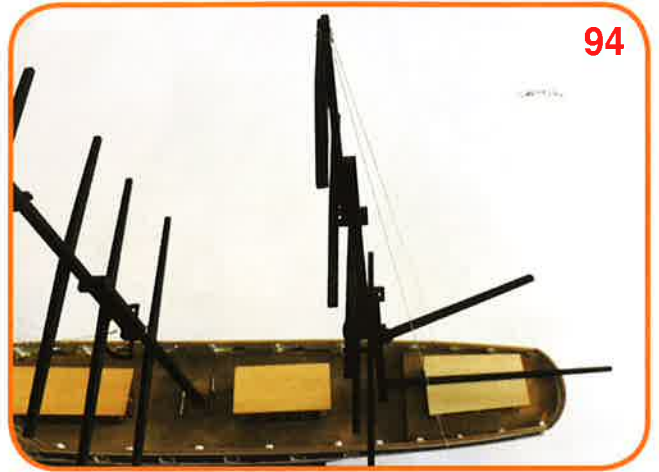
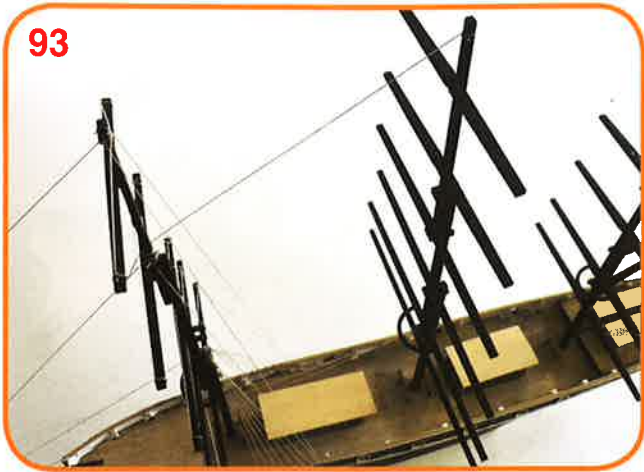
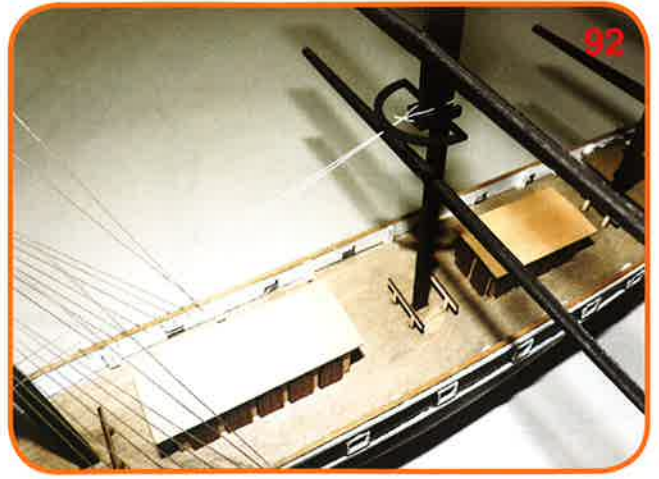
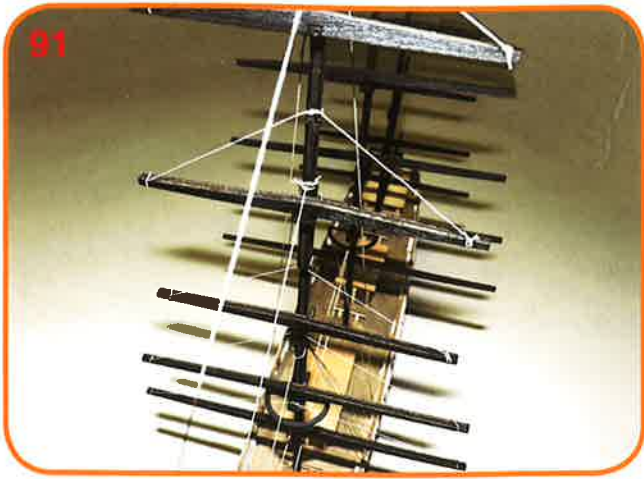

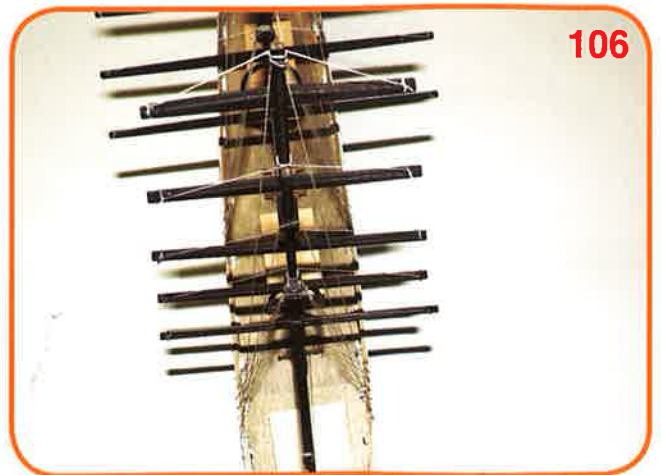
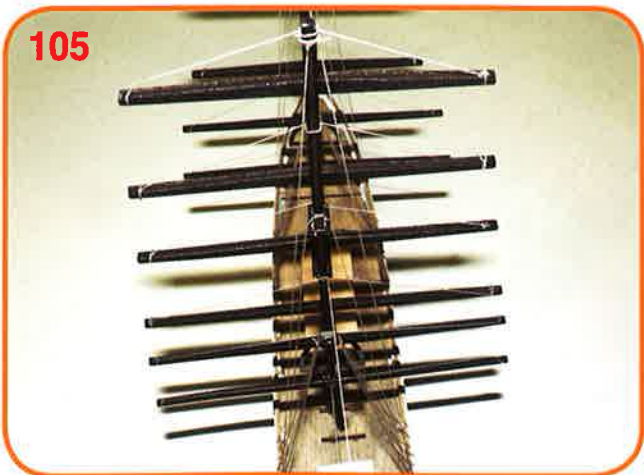
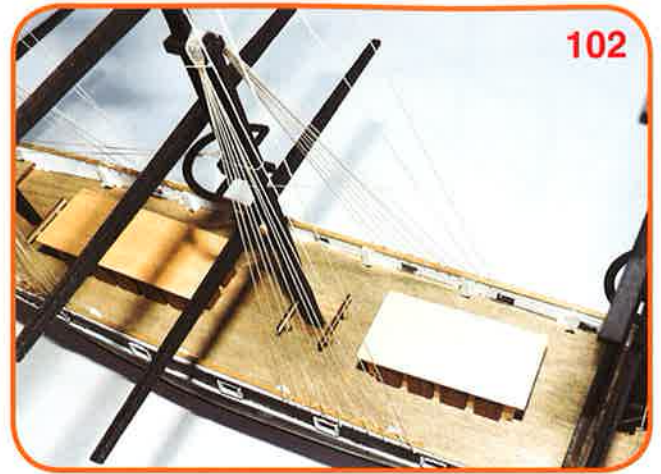
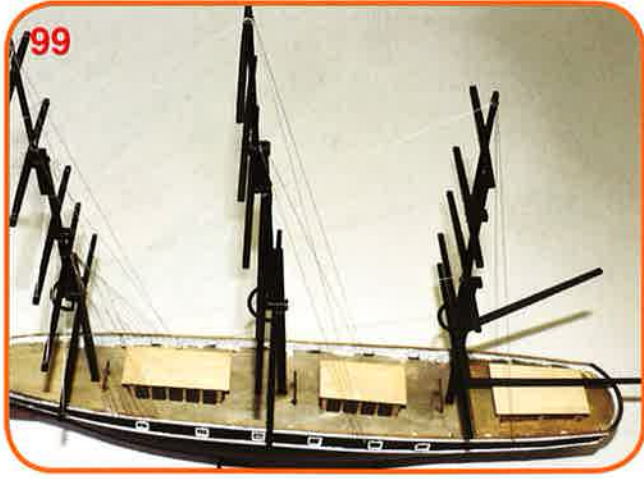

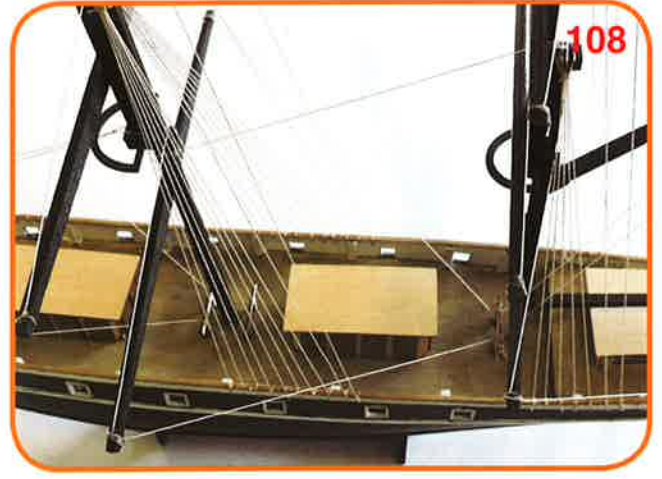



114



113

| LISTA DEI MATERIALI | MATERIAL LIST | MATERIALLISTE | LISTE DI MATÉRIEL | MATERIALELIJST | LISTA DE MATERIALES | mm. | Quan. Anz. | Disegno N. |
|---------------------|------------------------|----------------------------|------------------------------|------------------------|------------------------|-------------|------------|--|
| Descrizione | Description | Beschreibung | Description | Beschrijving | Description | | Aan. | Ident N. Nr. |
| Tavola compensato | Plywood board | Sperrholzplatte | Planche contreplaqué | Plaat triplex | Tabla chapa | 3x180x485 | 1 | 1-2-3-4-5-6-7-8-9-10-11-12-13-14-15-16-17-18 |
| Tavola compensato | Plywood board | Sperrholzplatte | Planche contreplaqué | Plaat triplex | Tabla chapa | 3x150x365 | 1 | 19-20-21-22-48-49-50-51-52-54-55-56-57-58-59-60-61-62-63-64-66-67-68-69-70-71-72-73-74-75-77-78-79-80-81-82-83-84-85 |
| Tavola laser-incisa | Laser engraved sheet | Laser eingeschnitten | Planche laser-gravée | Laser ingesneden plank | Tabla laser grabó | 1,2x180x485 | 1 | 23-24-25-26-27-28-29-30-31-32-33-34-35-36-37-38-39-40-41-42-43-44-45-46-47-53-65-76 |
| Tavola laser-incisa | Laser engraved sheet | Laser eingeschnitten | Planche laser-gravée | Laser ingesneden plank | Tabla laser grabó | 1x65x135 | 1 | 86-88-89 |
| Listelli tiglio | Lime wood strips | Lindenholzleisten | Listeaux en tilleul | Strips in lindehout | Tiras de madera | 1x3x460 | 46 | - |
| Listelli noce | Walnut strips | Nußbaumleisten | Listeaux en noyer | Strips notelaar | Listones de nogal | 1x2x460 | 7 | - |
| Listelli noce | Walnut strips | Nußbaumleisten | Listeaux en noyer | Strips notelaar | Listones de nogal | 1x3x460 | 2 | - |
| Canapa | Rope | Takelgarn | Cor dage | Touw | Cañamo | ø 0,25 | 30 mt | - |
| Polena | Cast figure head | Gallonsfiguren | Figure de proue | Boegbeeld, gietijzer | Mascarón de proa | - | 1 | 87 |
| Cerniere timone | Rudder hinges | Ruderscharniere | Charnière de gouvernail | Roerscharnieren | Bisagras de timón | - | 4 | 90 |
| Chiodini ottone | Brass nails | Drahtstifte, Messing | Crous en laiton | Nagels | Ciavos de latón | - | 16 | 91 |
| Perni cerniere | Hinge pin | Wellen für Ruderscharniere | Axes de charnières | Scharnieren pinnen | Pernos de bisagras | - | 2 | 92 |
| Occhiello | Eye-lets | Augbolzen | Pitons | Oogvijzen | Escotas | ø 3,5x8 | 2 | 93 |
| Libretto istruzioni | Booklet with instruct. | Anleitungen | Livret pour les instructions | Handleiding | Libro de instrucciones | - | 1 | - |